

STRONGHOLD™

CONTRACTOR PRODUCTS CATALOG



PANDUIT®

StrongHold Contractor Products is a sub brand of Panduit Corporation. Panduit is a leading global provider of electrical and network infrastructure solutions, with a unique understanding of the complexities of infrastructure construction.

StrongHold was created to focus on meeting the constantly adapting installation and maintenance needs of our customers. This offering provides reliable, convenient, and economical product options to support the way electrical contractors work.

Table of Contents

StrongHold™ Cable Ties	3-5
StrongHold™ Cable Tie Accessories	6
StrongHold™ Stainless Steel Cable Ties.	7-8
StrongHold™ Electrical Tape.	9-13
StrongHold™ Terminals.	14-16
StrongHold™ Wire Marker Books	17
StrongHold™ Supports & Fasteners	18-33
Cable/Conduit.	19-21
Beam/Purlin	22-23
Stud Wall	24-26
Communication/Low Voltage	27-31
Dry Wall.	32
Acoustical	33
Convenient Sizing Information	34-35
Codes and Standards	36-41
Part Number Index	42-43

StrongHold™ Cable Tie

StrongHold™ offers contractors economical cable tie options for commercial construction including locking, releasable, and clamp ties. The line features a variety of plenum-rated nylon cable ties in natural, UV weather resistant black, and red, suitable for both indoor and outdoor applications. In addition, StrongHold™ offers a comprehensive assortment of cable tie mounts to complement our cable tie offering. Our mounts feature Adhesive Back Mounts and Screw Mounts in natural and black nylon materials, suitable for securing wires and cables quickly. Combined with StrongHold™ cable ties, our mounts offer you the best routing solution for your application needs.

Panduit offers a wide variety of specialty cable tie products that are suitable for harsh and heavy duty applications. For more information on specialty cable ties and related products visit: www.panduit.com



Cable Ties

Part Number	Length in (mm)	Maximum Bundle Diameter in (mm)	Width in (mm)	Std Pkg Qty	Color	AH-2 Plenum Rated	UV Resistant	cULus Listed 62275 Type 2,21	CE Declaration
Miniature Cable Ties 18 lbs (80N)									
S4-18-C	3.94 (100)	0.87 (22)	0.10 (2.5)	100	Natural	✓	No	✓	✓
S4-18-M				1000			No		
S4-18-C0				100	Black		✓		
S4-18-M0				1000			No		
S6-18-C	6.29 (160)	1.57 (40)		100	Natural		No		
S6-18-M				1000			✓		
S6-18-C0				100	Black		✓		
S6-18-M0				1000			No		
S8-18-C	7.87 (200)	2.09 (53)	100	Natural	No				
S8-18-M			1000		✓				
S8-18-C0			100	Black	✓				
S8-18-M0			1000		No				
Intermediate Cable Ties 40 lbs (178 N)									
S6-40-C	5.51 (140)	1.30 (33)	0.14 (3.6)	100	Natural	✓	No	✓	✓
S6-40-M				1000			No		
S6-40-C0				100	Black		✓		
S6-40-M0				1000			No		
S8-40-C	7.87 (200)	2.09 (53)		100	Natural		No		
S8-40-M				1000			✓		
S8-40-C0				100	Black		✓		
S8-40-M0				1000			No		
S12-40-C	11.81 (300)	2.99 (76)	100	Natural	No				
S12-40-M			1000		✓				
S12-40-C0			100	Black	✓				
S12-40-M0			1000		No				
S15-40-C	14.57 (370)	4.02 (102)	100	Natural	No				
S15-40-C0			100	Black	No				

StrongHold™ Cable Tie



Cable Ties

Part Number	Length in (mm)	Maximum Bundle Diameter in (mm)	Width in (mm)	Std Pkg Qty	Color	AH-2 Plenum Rated	UV Resistant	cULus Listed 62275 Type 2,21	CE Declaration
Standard Cable Ties 50 lbs (222 N)									
S5-50-C	4.72 (120)	0.94 (24)	0.19 (4.8)	100	Natural	✓	No	✓	✓
S5-50-M				1000			✓		
S5-50-C0				100	Black		✓		
S5-50-M0				1000			No		
S6-50-C	6.30 (160)	1.50 (38)		100	Natural		No		
S6-50-M				1000			✓		
S6-50-C0				100	Black		✓		
S6-50-M0				1000			No		
S7-50-C	7.40 (188)	1.81 (46)		100	Natural		No		
S7-50-M				1000			✓		
S7-50-C0				100	Black		✓		
S7-50-M0				1000			No		
S7-50-C2	8.46 (215)	2.09 (53)		100	Red		✓		
S8-50-C				Natural	✓				
S8-50-M					1000		No		
S8-50-C0				100	Black		✓		
S8-50-M0	1000	No							
S10-50-C	9.84 (250)	1.97 (50)		100	Natural		No		
S10-50-C0				100			✓		
S12-50-C				11.81 (300)	2.99 (76)		1000		
S12-50-M			100			✓			
S12-50-C0	1000	No							
S12-50-M0	1000	✓							
S15-50-C	14.57 (370)	4.02 (102)	100	Red	No				
S15-50-M			Natural	✓					
S15-50-C0				100	Black	✓			
S15-50-M0			1000	No					
S15-50-C2	16.90 (430)	4.33 (110)	100	Red	✓				
S17-50-C			Natural	No					
S17-50-M				1000	✓				
S17-50-C0			100	Black	✓				
S17-50-M0	1000	No							
S21-50-C	20.87 (530)	5.51 (140)	100	Natural	No				
S21-50-M			1000		✓				
S21-50-C0			100	Black	✓				
S21-50-M0			1000		No				

StrongHold™ Cable Tie

Cable Ties



Part Number	Length in (mm)	Maximum Bundle Diameter in (mm)	Width in (mm)	Std Pkg Qty	Color	AH-2 Plenum Rated	UV Resistant	cULus Listed 62275 Type 2,21	CE Declaration		
Light Heavy Cable Ties 120 lbs (534 N)											
S14-120-L	14.49 (368)	4.02 (102)	0.30 (7.6)	50	Natural	✓	No	✓	✓		
S14-120-TL				250			No			✓	
S14-120-L0				50	Black						✓
S14-120-TL0				250			No			✓	
S18-120-L	17.71 (450)	5.12 (132)		50	Natural						No
S18-120-L0				50	Black		✓				
S21-120-L	20.98 (533)	5.51 (140)		100	Natural		No				
S21-120-C				50	Black		✓				
S21-120-L0										50	Black
S21-120-C0				100	No		✓				
S24-120-Q	23.62 (600)	6.69 (170)		25						Natural	No
S24-120-L				50	Black		✓				
S24-120-Q0				25						No	✓
S24-120-L0				50	Black		✓				
S30-120-X	29.53 (750)	8.58 (218)		10						Natural	No
S30-120-L				50	Black		✓				
S30-120-X0			10	No		✓					
S30-120-L0			50		Black		✓				
Heavy Cable Ties 175 lbs (778 N)											
S18-175-L	17.71 (450)	5.20 (132)	0.35 (9.0)	50	Natural	No	✓	✓	✓		
S18-175-L0					50	Black				✓	
S21-175-L	20.86 (530)	5.51 (140)		100	Natural	No					
S21-175-C				50	Black	✓					
S21-175-L0										50	Black
S21-175-C0				100	No	✓					
S24-175-L	24.02 (610)	7.00 (178)		50						Natural	No
S24-175-L0				50	Black	✓					
S31-175-L	30.55 (776)	8.98 (228)		50	Natural	No					
S31-175-L0				50	Black	✓					
S32-175-L				32.12 (816)	9.41 (239)	50				Natural	No
S32-175-L0						50				Black	✓
S36-175-L	35.91 (912)	10.35 (263)		50	Natural	No					
S36-175-L0				50	Black	✓					
S40-175-X				40.16 (1020)	11.61 (295)	10				Natural	No
S40-175-L	50	Black				✓					
S40-175-X0	10		No				✓				
S40-175-L0	50	Black				✓					
S48-175-L	48.03 (1220)		14.37 (365)	50	Natural		No				
S48-175-L0		50		Black	✓						
S48-175-L8		50		Gray	No						
Cable Ties, Releasable, 50 lbs (222 N)											
SR8-50-C	7.87 (200)	1.97 (50)	0.19 (4.8)	100	Natural	✓	No	✓	✓		
SR8-50-C0					Black	✓	✓				
Cable Ties, Clamp Style, 50 lbs (222 N) - Clamp Mount takes #10 / M5 Screw											
SC8-50-S10-C	7.87 (200)	1.97 (50)	0.19 (4.8)	100	Natural	No	No	✓	✓		
SC8-50-S10-C0					Black	✓	✓				
SC15-120-S25-L	14.96 (380)	3.86 (98)	0.30 (7.6)	50	Natural	No	No	✓	✓		
SC15-120-S25-L0					Black	✓	✓				

StrongHold™ Cable Tie Accessories

Low Profile Cable Tie Anchor Mounts



Part Number	Length in (mm)	Width in (mm)	Height in (mm)	Material	Used with Stronghold Cable Ties	Hole Diameter in (mm)	Mounting Method	Std Pkg Qty	Std Pkg Qty
Anchor Mounts									
SSMTA-M	0.75 (19.0)	0.38 (9.5)	0.20 (5.1)	Nylon 6.6	S*-18, S*-40, S*-50	0.17 (4.3)	#8 (M4) Screw	1000	5000
SSMTA-C								100	500

Standard Screw Applied Cable Tie Mounts



Part Number	Length in (mm)	Width in (mm)	Height in (mm)	Material	Used with Stronghold Cable Ties	Hole Dia. in (mm)	Mounting Method	Std Pkg Qty	Std Pkg Qty
Cable Tie Mounts									
SSM2S6-M	0.63 (16.0)	0.43 (10.8)	0.28 (7.0)	Nylon 6.6	S*-18, S*-40, S*-50	0.29 (7.1)	#6 (M3) Screw	1000	5000
SSM2S6-C				100				500	
SSM2S6-3X				30				300	
SS2S6-M0	0.63 (16.0)	0.43 (10.8)	0.28 (7.0)	Weather Resistant Nylon 6.6	S*-18, S*-40, S*-50	0.29 (7.1)	#6 (M3) Screw	1000	5000
SSM2S6-C0				100				500	
SSM2S6-3X0				30				300	
SSM3S8-M	0.86 (21.9)	0.61 (15.5)	0.37 (9.4)	Nylon 6.6	S*-18, S*-40, S*-50, S*-120	0.32 (8.1)	#8 (M4) Screw	1000	5000
SSM3S8-C				100				500	
SSM3S8-3X				30				300	
SSM3S8-M0	0.86 (21.9)	0.61 (15.5)	0.37 (9.4)	Weather Resistant Nylon 6.6	S*-18, S*-40, S*-50, S*-120	0.32 (8.1)	#8 (M4) Screw	1000	5000
SSM3S8-C0				100				500	
SSM3S8-3X0				30				300	

Low Profile Screw Applied Cable Tie Mounts



Part Number	Length in (mm)	Width in (mm)	Height in (mm)	Material	Used with Stronghold Cable Ties	Hole Dia. in (mm)	Mounting Method	Std Pkg Qty	Std Pkg Qty
Cable Tie Mounts									
SSMLP-M	0.75 (19.1)	0.50 (12.7)	0.12 (3.0)	Nylon 6.6	S*-18, S*-40, S*-50	0.17 (4.3)*	#8 (M4) Countersunk Screw	1000	5000
SSMLP-C								100	500

Adhesive Backed Mounts



Part Number	Size (LxW) in	Size (LxW) (mm)	Material	Used with Stronghold Cable Ties	Std Pkg Qty	Std Ctn Qty	
Cable Tie Mounts							
SMP12A-3X	0.79 x 0.79	20 x 20	Nylon 6.6	S*-18, S*-40	30	300pcs	
SMP12A-C					100	1000pcs	
SMP12A-M					1000	5000pcs	
SMP16A-3X	1.00 x 1.00	25 x 25		S*-18, S*-40, S*-50	30	300pcs	
SMP16A-C					100	1000pcs	
SMP16A-M					1000	5000pcs	
SMP18A-3X	1.18 x 1.18	30 x 30	S*-18, S*-40, S*-50		30	300pcs	
SMP18A-C					100	1000pcs	
SMP18A-M					1000	5000pcs	
SMP12A-3X0	0.79 x 0.79	20 x 20		Nylon 6.6 (Black)	S*-18, S*-40	30	300pcs
SMP12A-C0						100	1000pcs
SMP12A-M0						1000	5000pcs
SMP16A-3X0	1.00 x 1.00	25 x 25	S*-18, S*-40, S*-50		S*-18, S*-40, S*-50	30	300pcs
SMP16A-C0						100	1000pcs
SMP16A-M0						1000	5000pcs
SMP18A-3X0	1.18 x 1.18	30 x 30		S*-18, S*-40, S*-50	S*-18, S*-40, S*-50	30	300pcs
SMP18A-C0						100	1000pcs
SMP18A-M0						1000	5000pcs

StrongHold™ Stainless Steel Cable Ties

StrongHold offers a comprehensive selection of stainless steel products such as Metal Locking Ties (IMLT) and Custom Length Strapping (IMS) in uncoated and fully coated options to deliver high performance, strength, and reliability against harsh environments. Suitable for the following environments; Solar, Chemical Plants and Refineries, Industrial Construction, Mining, Oil and Gas, MRO, and Shipbuilding.



Part Number	Material	Max Bundle Diameter in (mm)	Min Loop Tensile Strength (Lbs/N)	Length in (mm)	Width in (mm)	Thickness in (mm)	Recommended Tool	Std Pkg Qty	Std Ctn Qty
Stronghold™ Stainless Steel Cable Ties									
IMLT25S-C	304	1.0 (25)	125/556	5.0 (127)	0.18 (4.60)	0.01 (0.25)	GS4MT-E, HTMT, PPTMT, ST2MT	100	500
IMLT51S-C		2.0 (51)		7.9 (201)					
IMLT102S-C		4.0 (102)		14.3 (362)					
IMLT152S-C		6.0 (152)		20.5 (521)					
IMLT203S-C		8.0 (203)		26.7 (679)					
IMLT254S-C		10.0 (254)		33 (838)					
IMLT304S-Q		12.0 (304)		39.3 (998)					
IMLT25S-C6L	316L	1.0 (25)	125/556	5.0 (127)	0.18 (4.60)	0.01 (0.25)	GS4MT-E, HTMT, PPTMT, ST2MT	100	500
IMLT51S-C6L		2.0 (51)		7.9 (201)					
IMLT69S-C6L		2.7 (69)		10.2 (259)					
IMLT102S-C6L		4.0 (102)		14.3 (362)					
IMLT152S-C6L		6.0 (152)		20.5 (521)					
IMLT203S-C6L		8.0 (203)		26.7 (679)					
IMLT254S-C6L		10.0 (254)		33 (838)					
IMLT304S-Q6L	12.0 (304)	39.3 (998)							
IMLT51H-L	304	2.0 (51)	200/890	7.9 (201)	0.31 (7.9)	0.01 (0.25)	GS4MT-E, HTMT, PPTMT, ST2MT, PBTMT	50	250
IMLT102H-L		4.0 (102)		14.3 (362)					
IMLT152H-L		6.0 (152)		20.5 (521)					
IMLT203H-L		8.0 (203)		26.7 (679)					
IMLT254H-L		10.0 (254)		26.73 (679)					
IMLT355H-Q		14.0 (355)		45.5 (1156)					
IMLT51H-L6L	316L	2.0 (51)	200/890	7.9 (201)	0.31 (7.9)	0.01 (0.25)	GS4MT-E, HTMT, PPTMT, ST2MT, PBTMT	50	250
IMLT69H-L6L		2.7 (69)		10.2 (259)					
IMLT102H-L6L		4.0 (102)		14.3 (362)					
IMLT152H-L6L		6.0 (152)		20.5 (521)					
IMLT203H-L6L		8.0 (203)		26.7 (679)					
IMLT254H-L6L		10.0 (254)		33.0 (838)					
IMLT304H-Q6L		12.0 (304)		39.3 (998)					
IMLT355H-Q6L	14.0 (355)	45.5 (1156)							

StrongHold™ Self-Locking Fully Coated Cable Ties



Part Number	Material	Max Bundle Diameter (in/mm)	Min Loop Tensile Strength (N/Lbs)	Length (in/mm)	Width (in/mm)	Thickness (in/mm)	Recommended Tool	Std Pkg Qty	Std Ctn Qty
StrongHold™ Self-Locking Fully Coated Cable Ties									
IMLTFC38S-C6L	316L	1.5/38	100/445	6.2/158	0.18/4.6	0.02/0.4	GS4MT-E, HTMT, PPTMT, ST2MT	100	500
IMLTFC51S-C6L		2.0/51		7.9/201					
IMLTFC64S-C6L		2.5/64		9.4/233					
IMLTFC86S-C6L		3.4/86		12.2/310					
IMLTFC102S-C6L		4.0/102		14.3/362					
IMLTFC137S-C6L		5.4/137		18.2/462					
IMLTFC152S-C6L		6.0/152		20.5/521					
IMLTFC203S-C6L		8.0/203		26.7/679					
IMLTFC38H-C6L		200/890	1.5/38	.31/8.0	6.2/158	GS4MT-E, HTMT, PPTMT, ST2MT, PBMT	50	250	
IMLTFC51H-L6L			2.0/51		7.9/201		100	500	
IMLTFC64H-C6L			2.5/64		9.4/233		50	250	
IMLTFC69H-L6L			2.7/69		10.2/259		100	500	
IMLTFC86H-C6L			3.4/86		12.2/310		50	250	
IMLTFC102H-L6L			4.0/102		14.3/362		100	500	
IMLTFC137H-C6L			5.4/137		18.2/462		50	250	
IMLTFC152H-L6L			6.0/152		20.5/521		50	250	
IMLTFC203H-L6L			8.0/203		26.7/679				

StrongHold™ Stainless Steel Straps and Buckles



Part Number	Material	Length (m/ft)	Strap Breaking Strength (N/Lbf)	Min Bundle Diameter (mm/in)	Width (mm/in)	Thickness (mm/in)	Recommended Installation Tool	Std Pkg Qty
StrongHold™ Metal Strapping (Uncoated) - Coil								
IMS9.5T35-QR6L	Stainless Steel Type 316L	25/82	1780/400	26/1.02	9.5/0.37	0.35/0.014	BT75SDT	1
IMS12T35-QR6L			2445/550		12/0.47			
IMS16T35-QR6L			3110/699		16/0.62			
IMS19T75-QR6L			4225/950		19/0.75			
StrongHold™ Metal Strapping (Coated with Epoxy Polyester) - Coil								
IMSP9.5T35-QR6L	Stainless Steel Type 316L	25/82	1780/400	26/1.02	9.5/0.37	0.35/0.014 [^]	BT75SDT	1
IMSP12T35-QR6L			2445/550		12/0.47			
IMSP16T35-QR6L			3110/699		16/0.62			

[^]Base material less coating (coating thickness 0.05mm-0.15mm per side)



Part Number	Material	Thickness (mm/in)	Part Description	Std Pkg Qty
StrongHold™ Buckles				
IMSBL9.5-C6L	Stainless Steel Type 316L	9.5/0.37	Individual Buckle Style L for use with 9.5 mm strapping	100
IMSBL12-C6L		12/0.47	Individual Buckle Style L for use with 12 mm strapping	
IMSBL16-C6L		16/0.62	Individual Buckle Style L for use with 16 mm strapping	
IMSBE19-C6L		19/0.75	Individual Buckle Style E for use with 19 mm strapping	

Stronghold™ Electrical Tape

StrongHold offers a variety of electrical tape suitable for a wide range of indoor and outdoor applications and temperatures. Whether your application calls for high resistance to sun, water, oil, acids alkalis, and corrosive chemicals, primary insulation for splicing, or phase identification, StrongHold tapes have you covered. Check out our full offering of PVC, Rubber, Mastic, and Friction tapes.

Check out our full offering of PVC, Rubber, Mastic, and Friction tapes!

- [PVC](#)
- [Rubber](#)
- [Mastic](#)
- [Friction](#)



StrongHold™ PVC Electrical Tape

ST88 Heavy Duty Tape

StrongHold ST88 Series Heavy Duty PVC Electrical Tape is an all-weather, pressure sensitive vinyl electrical tape that applies easily and provides a high level of performance over a range of temperatures. The ST88 series product is flame retardant and cold resistant. ST88 is suitable as a primary insulation when used for splicing up 600 Volts and can be used as a protective outer jacket over splices in low temperature applications.



Heavy Duty Electrical PVC Vinyl Tape Offering

Part Number	Case Qty	Minimum Order Quantity	Color	Thickness	Dimension
ST88-075-66BK	100	20	Black	.0085" (.21mm)	3/4" x .0085" x 66'
ST88-100-108BK	80				1" x .0085" x 108'
ST88-150-66BK	100				1.5" x .0085" x 66'
ST88-200-66BK	40				2" x .0085" x 66'

Panduit® PVC Tape

ST35 & ST43 Professional Grade Tape

StrongHold ST35 Series Professional Grade PVC Electrical Tape is a pressure sensitive vinyl electrical tape that applies easily and provides a high level of performance over a range of temperatures. The ST35 series product is flame retardant and cold resistant. ST35 is suitable as a primary insulation when used for splicing up 600 Volts and can be used as a protective outer jacket over splices in low temperature applications.



Professional Grade Electrical PVC Vinyl Tape Offering

Part Number	Case Qty	Min. Order Qty	Color	Thickness	Dimension
ST35-075-66BU	20	20	Blue	.007" (.18mm)	0.75" x 0.007" x 66'
ST35-075-66BR			Brown		
ST35-075-66GY			Gray		
ST35-075-66GR			Green		
ST35-075-66OR			Orange		
ST35-075-66RD			Red		
ST35-075-66VI			Violet		
ST35-075-66WH			White		
ST35-075-66YL			Yellow		
ST43-075-66BK			Black		

ST14 & ST17 General Purpose Tape

StrongHold ST14 & ST17 General Purpose PVC Electrical Tape is a one sided rubber based, pressure sensitive adhesive glossy finish vinyl electrical tape. The ST17 series product is non-corrosive and has pressure-sensitive adhesive which eliminates the need for heat, moisture and or other catalysts to affect the application. The high elongation makes it easy to tear while having excellent conformability properties. The product is UL and CSA Listed, flame retardant, as well as cold resistant. ST14 & ST17 is suitable as an electrical insulation when used for splicing up 600 Volts or 80°C (176°F).

ST15 General Purpose Tape

StrongHold ST15 General Purpose PVC Electrical Tape is a one sided coating of rubber based, pressure sensitive adhesive matte finish vinyl electrical tape. The ST15 series product is non-corrosive and has pressure-sensitive adhesive which eliminates the need for heat, moisture and or other catalysts to affect the application. The high elongation makes it easy to tear while having excellent conformability properties. The product is nonflammable. ST15 is suitable as an electrical insulation when used for splicing up 600 Volts or 80°C (176°F).



General Purpose Electrical PVC Vinyl Tape Offering



Part Number	Case Qty	Min. Order Qty	Color	Thickness	Dimension		
ST17-075-66BU	100	100	Blue	.007" (.18mm)	0.75" x 0.007" x 66'		
ST17-075-66BR			Brown				
ST17-075-66GY			Gray				
ST17-075-66GR			Green				
ST17-075-66OR			Orange				
ST17-075-66RD			Red				
ST17-075-66YL			Yellow				
ST17-075-66VI			Violet				
ST17-075-66WH			White				
ST14-075-60BK			Black				
ST15-075-66GRYL			Yellow with Green Stripes			.005" (.13mm)	0.75" x 0.005" x 66'

StrongHold™ Specialty Tape

ST130 Series Linerless High Voltage Rubber Tape

StrongHold ST130 Series Tape is an ethylene based high voltage tape with exceptional electrical, chemical and physical properties. It is a linerless, self-bonding tape that permits faster taping speeds than that of a tape with a liner and yields a uniform, void-free build-up. The ST130 series tape is compatible with all extruded cable insulations and is specially formulated to have excellent thermal conductivity allowing for proper heat dissipation from a joint.

Used for:

- Insulation and jacket for power cables up to 69Kv
- Building stress cones and jacket of termination on power cables up to 35Kv
- Insulation and protection of bus bars and joints



Part Number	Part Description	Width in (mm)	Length ft (m)	Thickness in (mm)	Voltage	Temp	Color	Moisture Resistant	UV Resistant	Min Order Qty
ST130-075-30BK	Linerless High Voltage Rubber Tape	0.75" (19)	30' (9.1)	.030" (.76)	600 V – 69 KV	90 °C Max	Black	Y	Y	20
ST130-100-30BK		1.00" (25)								
ST130-150-30BK		1.50" (38)								10

ST23 Series High Voltage Rubber Tape with Liner

StrongHold ST23 Series Tape with liner is a 30 mil (0,76mm) ethylene propylene rubber, self-amalgamating high voltage tape for insulating and jacketing splices through 69kV. It amalgamates quickly, yielding a void-free, electrically stable build-up and is ideal for waterproofing. Meets ASTM D-4388, HH-I-553C/Grade A, MIL-I3825B standards. Due to the highly stable mechanical and chemical properties of the ST23 series tape it is ideal for cable jacket repair and restoration.

Used for:

- Insulating and jacketing of splices on power cables up to 69Kv
- Building stress cones and jacket of termination on power cables up to 35Kv
- Waterproofing, insulating and protecting of bus components.



Part Number	Part Description	Width in (mm)	Length ft (m)	Thickness in (mm)	Voltage	Temp	Color	Moisture Resistant	UV Resistant	Min Order Qty
ST23-075-30BK	High Voltage Rubber Tape with Liner	0.75" (19)	30' (9.1)	.030" (.76)	600 V – 69 KV	90 °C Max	Black	Y	Y	20

ST2155 Series Mid-Grade Rubber Splicing Tape with Liner

StrongHold ST2155 Series Tape with liner is a 30 mil (0,76mm) self-amalgamating, low voltage rubber tape which is UL-510 Listed for use as primary insulation at not more than 600 volts. It easily conforms to irregular shapes and surfaces yielding a void free electrically stable build-up. The ST2155 Rubber splicing tape is compatible with all extruded dielectric cable insulations. Meets ASTM D-4388 type I standard.

Use for:

- Insulating of splices on solid dielectric cable thru 600 volts in conjunction with a jacketing tape.



Part Number	Part Description	Width in (mm)	Length ft (m)	Thickness in (mm)	Voltage	Temp	Color	Moisture Resistant	UV Resistant	Min Order Qty
ST2155-075-22BK	Mid Grade Rubber Splicing Lined	0.75" (19)	22' (6.7)	.030" (.76)	600 V Max	80 °C Continuous	Black	N	N	100

StrongHold™ Specialty Tape

ST2242 Series Linerless Mid-Grade Rubber Splicing Tape

StrongHold ST2242 Series Tape is a general-use ethylene rubber-based tape with excellent electrical, chemical and physical properties. It is a self-amalgamating linerless tape that permits faster taping speeds than a tape with a liner and yields a uniform, void-free build-up. The exceptional stretch capabilities allow the product to conform to various complex shapes and contours. The ST2242 series tape is compatible with all extruded cable insulations and is specially formulated to have excellent thermal conductivity allowing for proper heat dissipation from a joint.

Used for:

- Insulating and jacketing of splices on power cables up to 69Kv
- Building stress cones and jacket of termination on power cables up to 35Kv
- For insulating and protecting of bus bars and joints; and moisture sealing of motor leads and cable ends.



Part Number	Part Description	Width in (mm)	Length ft (m)	Thickness in (mm)	Voltage	Temp	Color	Moisture Resistant	UV Resistant	Min Order Qty
ST2242-075-15BK	Linerless Mid Grade Rubber Splicing Tape	0.75" (19)	15' (4.6)	.030" (.76)	600 V –69 KV	90 °C Max	Black	Y	Y	35
ST2242-150-15BK		1.50" (38)								

ST2210 Series Vinyl Mastic Tape

StrongHold ST2210 Series Vinyl Mastic Tape is a self-bonding mastic compound with an all-weather, premium vinyl backing that can be used for insulating and water sealing electrical connections through 600 volts. Small roll sizes can be stretched and molded around irregular shapes, even in tight locations. Provides excellent electrical properties, superior adhesion and moisture and chemical resistance. Vinyl backing adds UV protection. Use for sealing, insulating and padding all low voltage electrical connections.

Used for:

- Splicing and sealing applications in the Telecommunications, CATV and Electrical Industries.



Part Number	Part Description	Width in (mm)	Length ft (m)	Thickness in (mm)	Voltage	Temp	Color	Moisture Resistant	UV Resistant	Min Order Qty
ST2210-400-10BK	Vinyl Mastic	4.0" (102)	10' (3)	.05" (1.2)	600 V Max	90 °C Max	Black	Y	Y	10

ST2200 Series Vinyl Mastic Tape

StrongHold ST2200 Series Tape is a self-bonding insulating mastic with vinyl backing providing superior adhesion and dielectric strength required to seal and insulate electrical connections from buried, submerged or overhead cables up to 1000 volts. The vinyl backing adds mechanical strength and is resistant to UV rays. It is impermeable to ozone, water, soil dirt and corrosive chemicals. The ST2200 insulating mastic tape adheres quickly and permanently with no adverse effect to insulation or conductive polymer shielding. For application requiring in encapsulation and protecting direct buried low voltage connections and devices, terminations, overhead connectors, duct seals, and cable end seals.

Used for:

- Covering molded joints on CN cables.



Part Number	Part Description	Width in (mm)	Length ft (m)	Thickness in (mm)	Voltage	Temp	Color	Moisture Resistant	UV Resistant	Min Order Qty
ST2200-650-400P	Vinyl Mastic	6.50" (165)	4.00" (102)	.130" (3.3)	600 V Max	90 °C Max	Black	Y	Y	50 (5 boxes, 10 pads/box)

StrongHold™ Specialty Tape

ST2228 Series Rubber Mastic Tape

StrongHold ST2228 Series Rubber Mastic Tape a self-bonding mastic tape consisting of an ethylene propylene rubber (EPR) backing, bonded to a tacky temperature stable, electrical grade mastic. Provides excellent electrical properties, superior adhesion, moisture and chemical resistance. Can be stretched, wrapped or molded to irregular shapes providing insulation build up, water sealing and surface protection.

Used for:

- Corrosion protection and insulation of Bus Bars.
- Insulating and moisture-sealing of splices and terminations on solid dielectric cable
- Primary insulation up to 2kV



Part Number	Part Description	Width in (mm)	Length ft (m)	Thickness in (mm)	Voltage	Temp	Color	Moisture Resistant	UV Resistant	Min Order Qty
ST2228-100-10BK	Rubber Mastic	1.00" (25)	10' (3)	.065" (1.7)	2 KV Max	90 °C Max	Black	Y	Y	20
ST2228-200-10BK		2.00" (51)								10

StrongHold™ Friction Tape

ST1755 Series Friction Tape

StrongHold ST1755 Series Friction Tape is a high-quality cotton fabric coated on both sides with a black rubber adhesive compound, which provides good adhesion to all types of surfaces. A 0,38mm general purpose tape that provides excellent protection against abrasion. It provides mechanical protection against abrasion and penetration of cable, splices and wires.

Used for:

- Temporary binding and harnessing tape
- Covering tool handles for a non-slip surface and variety of other miscellaneous uses.



Part Number	Part Description	Width in (mm)	Length ft (m)	Thickness in (mm)	Voltage	Temp	Color	Moisture Resistant	UV Resistant	Min Order Qty
ST1755-075-60BK	Friction Tape	.75" (19)	60' (18)	.015" (.38)	N/A	80 °C Continuous	Black	N	N	100

StrongHold™ Terminal

StrongHold offers a vast variety of contractor grade terminals, disconnects, and splices with multiple sizes and insulation options. Contractor grade terminals are reliable and economical options that withstand a wide range of general purpose applications.



Narrow Fork Terminal

Product Number	AWG Wire Range (AWG)	Color	Stud/Tab Size	Std Pkg Qty
Narrow Fork Terminal, Insulated – Vinyl				
EV10-10FNB-Q	#12-10	Yellow	#10	25
EV10-8FNB-Q			#8	
EV14-10FNB-Q	#16-14	Blue	#10	
EV14-6FNB-Q			#6	
EV14-8FNB-Q			#8	



Locking Fork Terminal

Product Number	AWG Wire Range (AWG)	Color	Stud/Tab Size	Std Pkg Qty
Locking Fork Terminal, Insulated – Vinyl				
EV10-10LFB-Q	#12-10	Yellow	#10	25
EV10-14LFB-Q			1/4"	
EV10-6LFB-Q			#6	
EV10-8LFB-Q			#8	
EV14-10LFB-Q	#16-14	Blue	#10	
EV14-6LFB-Q			#6	
EV14-8LFB-Q			#8	
EV18-10LFB-Q	#22-18	Red	#10	
EV18-6LFB-Q			#6	
EV18-8LFB-Q			#8	



Female Disconnect Terminal

Product Number	AWG Wire Range (AWG)	Color	Stud/Tab Size	Std Pkg Qty
Female Disconnect Terminal, Insulated – Nylon				
EDNF10-250FI-Q	#12-10	Yellow	0.250" x 0.032"	25
EDNF14-188FIB-Q			0.187" x 0.020"	
EDNF14-250FIB-Q	#16-14	Blue	0.250" x 0.032"	
EDNF18-188FIB-Q			0.187" x 0.020"	
EDNF18-250FIB-Q	#22-18	Red	0.250" x 0.032"	



Ring Terminal

Product Number	AWG Wire Range (AWG)	Color	Stud/Tab Size	Std Pkg Qty
Ring Terminal, Insulated – Vinyl				
EV6-10R-Q	#6	Blue	#10	25
EV6-12R-Q			1/2"	
EV6-38R-Q			3/8"	
EV6-56R-Q			5/16"	
EV8-8R-Q	#8	Red	#8	
EV8-12R-Q			1/2"	
EV8-14R-Q			1/4"	
EV8-38R-Q			3/8"	
EV8-56R-Q	#12-10	Yellow	5/16"	
EV10-10RB-Q			#10	
EV10-12RB-Q			1/2"	
EV10-14RB-Q			1/4"	
EV10-38RB-Q			3/8"	
EV10-56RB-Q			5/16"	
EV10-6RB-Q			#6	
EV10-8RB-Q			#8	
EV14-10RB-Q	#16-14	Blue	#10	
EV14-14RB-Q			1/4"	
EV14-38RB-Q			3/8"	
EV14-6RB-Q	#22-18	Red	#6	
EV14-8RB-Q			#8	
EV18-8RB-Q			#8	
EV18-10RB-Q	#22-18	Red	#10	
EV18-14RB-Q			1/4"	
EV18-6RB-Q	#6			



Fork Terminal

Product Number	AWG Wire Range (AWG)	Color	Stud/Tab Size	Std Pkg Qty
Fork Terminal, Insulated – Vinyl				
EV10-10FB-Q	#12-10	Yellow	#10	25
EV10-14FB-Q			1/4"	
EV10-56FB-Q			5/16"	
EV10-6FB-Q			#6	
EV10-8FB-Q	#16-14	Blue	#8	
EV14-10FB-Q			#10	
EV14-14FB-Q			1/4"	
EV14-6FB-Q			#6	
EV14-8FB-Q	#22-18	Red	#8	
EV18-10FB-Q			#10	
EV18-6FB-Q			#6	
EV18-8FB-Q	#22-16	Red	#8	
EV18-14FB-Q			1/4"	

StrongHold™ Terminal

Female Disconnect Terminal



Product Number	Wire Range (AWG)	Color	Stud/Tab Size	Std Pkg Qty
Female Disconnect Terminal, Insulated – Vinyl				
EDV10-250-Q	#12-10	Yellow	0.250" x 0.032"	25
EDV14-250B-Q	#16-14	Blue	0.250" x 0.032"	
EDV18-250B-Q	#22-18	Red	0.250" x 0.032"	
EDV10-250FIB-Q	#12-10	Yellow	0.250" x 0.032"	
EDV14-250FIB-Q	#16-14	Blue	0.250" x 0.032"	
EDV18-250FIB-Q	#22-16	Red	0.250" x 0.032"	

Male Disconnect Terminal



Product Number	Wire Range (AWG)	Color	Stud/Tab Size	Std Pkg Qty
Male Disconnect Terminal, Insulated – Nylon				
EDNF14-187MB-Q	#16-14	Blue	0.187" x 0.032"	25
EDNF18-187MB-Q	#22-16	Red		
EDNF10250FIMB-Q	#12-10	Yellow	0.250" x 0.032"	
EDNF14250FIMB-Q	#16-14	Blue		
EDNF18250FIMB-Q	#22-18	Red		
Male Disconnect Terminal, Insulated – Vinyl				
EDV10-250M-Q	#12-10	Yellow	0.250" x 0.032"	25
EDV14-250M-Q	#16-14	Blue	0.250" x 0.032"	
EDV18-187MB-Q	#22-16	Red	0.187" x 0.032"	
EDV18-250M-Q	#22-18	Red	0.250" x 0.032"	

Butt Splice



Product Number	Wire Range (AWG)	Color	Std Pkg Qty
Butt Splice, Insulated – Vinyl			
ESV10BX-Q	#12-10	Yellow	25
ESV14BX-Q	#16-14	Blue	
ESV18BX-Q	#22-18	Red	

Piggy Back Disconnect Terminal



Product Number	Wire Range (AWG)	Color	Stud/Tab Size	Std Pkg Qty
Piggy Back Disconnect Terminal, Insulated – Vinyl				
EDV10-250P-Q	#12-10	Yellow	0.250" x 0.032"	25
EDV14-250P-Q	#16-14	Blue	0.250" x 0.032"	
EDV18-250P-Q	#22-18	Red	0.250" x 0.032"	

Female Bullet Terminal



Product Number	Wire Range (AWG)	Color	Bullet	Std Pkg Qty
Female Bullet Terminal, Insulated – Nylon				
EBNF14-4FIB-Q	#16-14	Blue	.156" / 3.9mm	25
EBNF18-4FIB-Q	#22-16	Red		
Female Bullet Terminal, Insulated – Vinyl				
EBV18-4B-Q	#22-16	Red	.156" / 3.9mm	25
EBV14-4B-Q	#16-14	Blue		

Male Bullet Terminal



Product Number	Wire Range (AWG)	Color	Bullet	Std Pkg Qty
Male Bullet Terminal, Insulated – Nylon				
EBNF14-4FIM-Q	#16-14	Blue	.156" / 3.9mm	25
EBNF18-4FIM-Q	#22-16	Red		

StrongHold™ Terminal

Step Down Splice



Product Number	AWG Wire Range (AWG)	Color	Std Pkg Qty
Step Down Splice, Insulated – Vinyl			
ESV10-ESV14-Q	#12-10 to 16-14, Yellow with Blue Color Ring	Yellow	25
ESV10-ESV18-Q	#12-10 to 22-18, Yellow with Red Color Ring	Yellow	
ESV14-ESV18-Q	#16-14 to 22-18, Blue with Red Color Ring	Blue	
ESV6-ESV8-Q	#6 to 8, Blue with Red Color Ring	Blue	
ESV8-ESV10-Q	#8 to 12-10, Red with Yellow Color Ring	Red	
ESV8-ESV14-Q	#8 to 16-14, Red with Blue Color Ring	Red	

Quick Splice



Product Number	AWG Wire Range (AWG)	Color	Std Pkg Qty
Quick Splice, Insulated – Polypropylene			
EQSP18D-Q	#22-16	Red	25
EQSP14D-Q	#18-14	Blue	
EQSP10-18D-Q	#12-10 to 18-14	Brown	
EQSP10-Q	#12-10	Yellow	
EQSP14-Q	#18-14	Blue	
EQSP18-Q	#22-18	Red	

Pin Terminal



Product Number	AWG Wire Range (AWG)	Color	Pin Diameter	Std Pkg Qty
Pin Terminal, Insulated – Vinyl				
EV10-P55-QYY	#12-10	Yellow	0.10" Dia.	25
EV14-P47B-Q	#16-14	Blue	0.07" Dia.	
EV18-P47B-Q	#22-18	Red		

Blade Terminal



Product Number	AWG Wire Range (AWG)	Color	Std Pkg Qty
Blade Terminal, Insulated – Vinyl			
EDV10-11MB-Q	#12-10	Yellow	25
EDV14-87MB-Q	#16-14	Blue	
EDV18-87MB-Q	#22-18	Red	

Wire Joint



Product Number	AWG Wire Range (AWG)	Color	Std Pkg Qty
Wire Joint, Insulated – Nylon			
EJN218-216-Q	#22-14	Clear	25
EJN418-212-Q	#18 -12		
EJN314-412-Q	#16-8		

Please note the following information regarding bag quantities:

-Q = Package quantity of 25

-L = Package quantity of 50 where applicable

See Panduit.com for individual part compliance and tooling options. All parts are ROHS compliant.

if you need bulk sizing, we offer terminals in bags of 500 and 1000.

StrongHold™ Wire Marker

StrongHold Marker Books features an assortment of conveniently pocket-sized pre-printed and self-laminating write-on marker book solutions used to identify many electrical and network components in markets such as Electrical, Industrial, Electronic, and Network. Marker books come in a variety of legends or ink receptive material for customization.

Pre-Printed Marker Books

- Convenient, pocket-sized book
- Markers are perforated and can be torn in half to mark both ends of conductors
- Terminal block markers are included to properly identify connectors
- Ten pages of markers per book
- Temperature range: -40°F to 170°F (-40°C to 77°C)



Part Number	Legend	Total Markers Each Legend	Std Ctn Qty	Min. Order Qty. Book(s)
PCMB-1	0 thru 9	45	10	10
PCMB-2	A thru Z, 0 thru 15, +, -, /	10		
PCMB-3	1 thru 45			
PCMB-4	1, 2, 3			
PCMB-5	A, B, C			
PCMB-6	T1, T2, T3	150		
PCMB-7	L1, L2, L3			
PCMB-8	1 thru 15 16 thru 90 A thru Z, +, -, /, 0			
PCMB-9	1, 2, 3, A, B, C L1, L2, L3, T1, T2, T3	45 30		
PCMB-11	1 thru 30 A thru Z	15 15		
PCMB-12	+ - Blank (write-on)	8 7 21		
PCMB-13	+ , -, AC, DC POS, NEG, GND NEUT SPARE, Blank (write-on)	45 21 21 21		
PCMB-14	46 thru 90	10		
PCMB-15	0, +, - 1 thru 45	15 10		
PCMB-16	0 thru 33, A, B, C, +, -, L1, L2, L3, T1, T2, T3	10		
PCMB-25	0 thru 9 - L1, L2, L3, T1, T2, T3	45 15		

Legend: Black
Background: White
Marker sizes:
Full size marker –
0.22" x 1.38" (5.60mm x 34.90mm).
Maximum wire O.D., 0.38" (9.50mm).
Half size marker –
0.22" x 0.69" (5.60mm x 17.40mm).
Maximum wire O.D., 0.19" (4.70mm).
Terminal block marker –
0.22" x 0.25" (5.60mm x 6.30mm).

Blank Self-Laminating Write-On Cable Marker Books

- 10 pages of markers per book
- Clear section of marker over laminates and protects printed legend
- Markers have ink receptive area to allow handwritten legends

Part Number	Print-on Area (in)	Width		Length		Markers Per Book	Std Pkg. Book(s)	Std Ctn. Book(s)
		in	mm	in	mm			
PSCB-12Y	0.62	0.50	12.7	1.50	38.1	180	1	10
PSCB-13Y	0.75	1.50	38.1	3.00	76.2	40		
PSCB-16Y	1.00			6.00	152.4	20		
PSCB-3Y	0.75	1.00	25.4	3.00	76.2	60		
PSCB-3YELY*				3.00	76.2			
PSCB-5Y	1.00			5.00	127.0	30		
PSCB-6Y				6.00	152.4			

*Yellow



StrongHold™ Electrical/Network Supports and Fasteners

StrongHold offers a complete line of supports and fasteners for the commercial and industrial construction market, providing customers everything they need to fix, route, secure, and manage power and communication cabling.

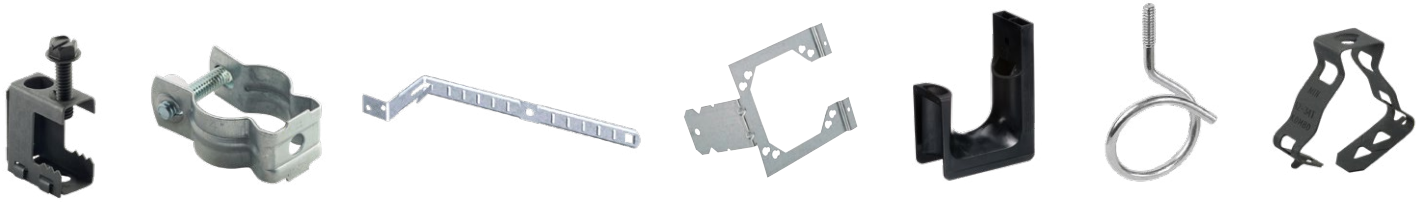

COMMUNICATION / LOW VOLTAGE

- J-Pro™ and J-Mod® J-hook cable supports for use in plenum or air-handling spaces; complete horizontal and vertical 1" bend radius control
- Bridle rings, suitable for low-voltage cabling only, available in a variety of mounting options

ACOUSTICAL

- Includes clips, assemblies and hangers
- Provide above T-bar support for troffers, fixtures, outlet boxes and conduit

DRY WALL

- Low-voltage mounting brackets, old world box mount and retainers
- Fasten electrical boxes to dry wall, rather than mounting to stud

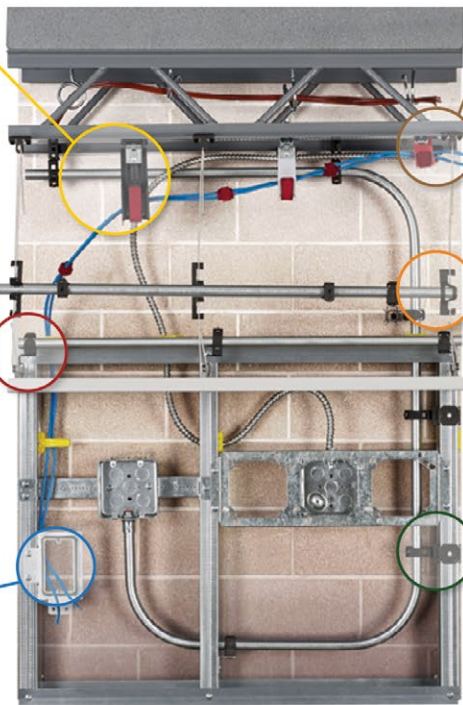

BEAM / PURLIN

- Beam clamps and purlin clips for attaching conduit and boxes to beams and vertical and angled flanges
- Screw-on, hammer-on and tool-less mounting options
- Various load capacities for multiple uses and needs

CABLE / CONDUIT

- Clips and clamps to support cable and conduit to most structures
- Options include snap-close, push-fit and flexible clips
- Brackets options to space, support and attach conduit

STUD WALL

- Brackets offer easy installation with screw-on options for attaching electrical boxes to wood and metal studs
- Supports are available in varied fittings, including push-fit, snap-on and screw-on
- Press-on nail plate and metal stud grommets to protect building infrastructure and cable building structure

StrongHold™ Cable/Conduit

Push-Fit Conduit Clips



- No fastener required to retain conduit
- Static load capacity:
 - 25 lbs. in vertical position
 - 15 lbs. in horizontal position
- Available with 1/4" non-threaded mounting hole

Part Number	Fits EMT (in)	Fits Rigid/IMC (in)	Std Pkg Qty
P16P	1	3/4	100

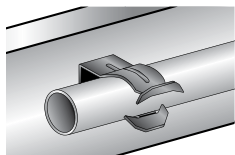

Conduit Clamps with Bolt



- Conduit hanger available for 1/2" – 4" conduit
- Bolt and nut (Phillips/flathead) provide positive securing feature
- Available with threaded and non-threaded mounting hole

Part Number	Fits EMT (in)	Fits Rigid/IMC (in)	Mounting Hole (in)	Std Pkg Qty
PCD0B	1/2	3/8 – 1/2	1/4 non-threaded	100
PCD1B	3/4	3/4		
PCD2B	1	1		

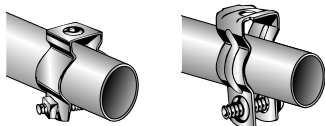

Snap-Close Conduit Clips with Beam Clamps – Bottom Mount



- Suspend conduit from bottom of beam
- Will pivot 360°
- Hammer-on installation
- Static load capacity: 75 lbs. vertically

Part Number	Flange Thickness (in)	Fits EMT/Rigid/IMC (in)	Std Pkg Qty
P6M24	1/8 – 1/4	3/8	100
P812M24		1/2 – 3/4	
P812M58	9/16 – 3/4		
P812M912			
P16M24	1/8 – 1/4	2	
P32M24			
P32M58	5/16 – 1/2		

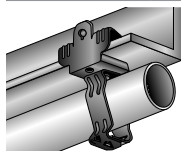

Snap-Close Conduit Clips with Beam Clamps – Side Mount



- Suspend conduit from side of beam
- Will pivot 360°
- Hammer-on installation
- Static load capacity: 25 lbs. vertically

Part Number	Flange Thickness (in)	Fits EMT/Rigid/IMC (in)	Std Pkg Qty
P6M24SM	1/8 – 1/4	3/8	100
P812M24SM		1/2 – 3/4	
P812M58SM	1		
P812M912SM			
P16M24SM	1/8 – 1/4	2	
P16M912SM			
P20M24SM	1/8 – 1/4		
P32M24SM			

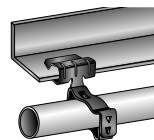

Push-Fit Conduit Clips with Beam Clamps



Image 1



Image 2

- Available in bottom mount or side mount options
- Will pivot 360°
- Hammer-on installation
- Static load capacity:
 - 25 lbs. vertically for bottom mount (Image 1)
 - 15 lbs. vertically for side mount (Image 2)

Part Number	Image No.	Flange Thickness (in)	Fits EMT (in)	Fits Rigid/IMC (in)	Std Pkg Qty
P12P24	1	1/8 – 1/4	3/4	1/2	100
P12P58		5/16 – 1/2			
P12P912		9/16 – 3/4			
P12P24SM	2	1/8 – 1/4			

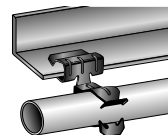
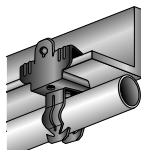

StrongHold™ Cable/Conduit

Cable Clips



- Support MC, AC, or BX cable from #12 – #8 wire in horizontal or vertical position
- No static load rating – for positioning only
- Can also be used for flexible metallic tubing, armored cable, portable cables, and control tubes
- See chart below for installation configurations

Part Number	Description	Std Pkg Qty
PKX	Cable clip to support MC, AC, or BX cable from drop wire.	100

Cable Size (in)	#12 Wire	#10 Wire	#8 – #9 Wire
14-2 (0.43 – 0.48 O.D.)	PKX	PKX	PKX
14-3 (0.45 – 0.50 O.D.)			
12-2 (0.47 – 0.51 O.D.)		PK8*	PK8*
12-3 (0.49 – 0.54 O.D.)			

*See PK8 on Page A.7.

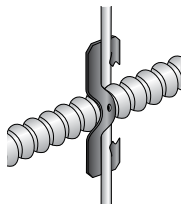

Multi-Function Clip Assemblies



Image 1 Image 2

- Components and assemblies used to secure conduit and devices to drop wire, rod, or flanges
- P4Z34 and assemblies fit 1/8" – 3/8" flanges and attach to #12 wire through 3/8" rod
- P6Z34 fits 1/8" – 7/16" flanges and attaches to #12 wire through 3/8" rod with improved performance
- No static load rating – for positioning only

Part Number	Image No.	Fits EMT (in)	Fits Rigid/IMC (in.)	Std Pkg Qty
P4Z34*	1	—	—	100
P6Z34*		—	—	

*UL and cUL listed.

Note: May require dedicated drop wire/rod and [PEC311](#) – consult local authority.

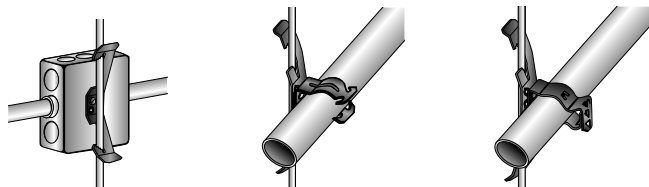

Conduit Clips



- Support conduit from drop wire, rod, or flange
- No static load rating – for positioning only
- Can also be used for flexible metallic tubing, armored cable, portable cables, and control tubes
- See chart below for installation configurations

Part Number	Description	Std Pkg Qty
PK8	Conduit clip to support 1/2" EMT from drop wire, rod, or flange.	100
PK12	Conduit clip to support 3/4" EMT from drop wire, rod, or flange.	
PK16*	Conduit clip to support 1" EMT from drop wire, rod, or flange.	

*Not UL or cUL listed.

Conduit Size (in)	#10 – #12 Wire	#8 – #9 Wire	3/16" – 1/4" Rod	1/8" – 1/4" Flange	5/16" – 1/2" Flange	9/16" – 3/4" Flange
1/2 EMT	PK8	PK8	PK8	PK8	PK12	PK12
1/2 Rigid		PK12	PK12	PK12		PK16
3/4 EMT	PK12		PK16	PK16	PK16	PK20*
3/4 Rigid		PK20*				
1 EMT	—	—	—	PK20*	—	—
1 Rigid	—	—	—	PK20*	—	—
1 1/4 EMT	—	—	—	PK20	—	—

*For horizontal applications only.

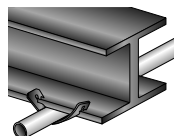

One-Piece Strut Clamps



- Used to mount conduit to strut
- All sizes available with load distribution saddle attached to screw to distribute weight
- Suitable for use with standard 1 5/8" strut
- Install with screwdriver, nut driver, or standard wrench

Part Number	Fits EMT (in)	Fits Rigid/IMC (in)	Static Load Capacity (lbs)	Std Pkg Qty
PSCH6B	3/8	—	—	100
PSCH12B	3/4	1/2	80	50
PSCH24B	1 1/2	1 1/4		
PSCH32B	2	1 1/2	100	25
PSCH72B	4	4	330	10

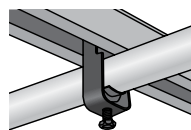

StrongHold™ Cable/Conduit

Universal Strut Clamps



- Break-apart strut clamp
- Install with screwdriver, nut driver, or standard wrench
- Suitable for use with standard 1 5/8" strut
- Material: mild steel

Part Number	Fits EMT/Rigid/IMC (in)	Static Load Rating (lbs)	Std Pkg Qty
PSK405I	2 1/2	350	50

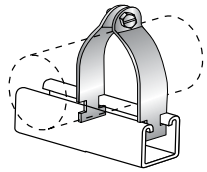

Combination Box/Conduit Hangers from Drop Wire, Rod, and Beams



Image 1



Image 2

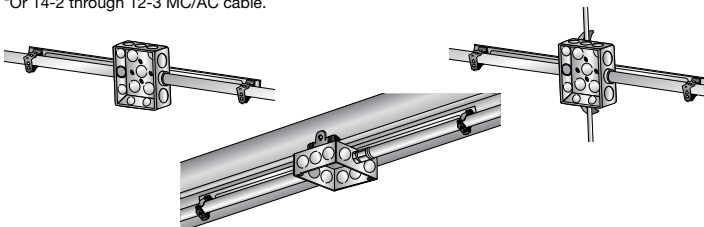

Image 3

- Secure 3/8" conduit (MC/AC cable) and 4" square boxes to most structures
- Provide 3/8" conduit (MC/AC cable) support on both sides of electrical box
- Available in a variety of mounting configurations

Part Number	Image No.	Mounting Method	Fits EMT/Rigid/IMC (in)	Std Pkg Qty
P6MB18A	2	Non-threaded center hole for screw or threaded rod mount	3/8*	25
P812MB18	1	#12 wire through 1/4" rod	1/2 – 3/4	
P812MB18A	2	Non-threaded center hole for screw or threaded rod mount		
P812MB18S	4	1/4-20 x 9/16" stud in center hole		
P16MB18A	2	Non-threaded center hole for screw or threaded rod mount	1	

*Or 14-2 through 12-3 MC/AC cable.



Flexible Conduit/Cable Clips

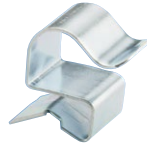

- Suitable for flexible conduit and all types of cable
- Support cable from 1/16" - 9/32" flange
- No static load rating – for positioning only
- Clip “snaps” on flange and cable “snaps” into clip

Part Number	AC/MC Cable O.D. (in)	Flange Size (in)	Std Pkg Qty
PSC2B	0.31 – 0.38	1/16 – 3/16	100
PSC2C	0.38 – 0.44		
PSC4B	0.31 – 0.38	3/16 – 9/32	
PSC4C	0.38 – 0.44		
PSC4D	0.47 – 0.56		
PSC4E	0.50 – 0.72		

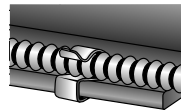

Support Brackets for MC/AC Cable



Mount with self-tapping screws found on page 26



- Properly space and support MC/AC cable
- Prevent derating of electrical cable
- Comply with NEC Article 310.15 (reference pages O.4 – O.5 for details)

Part Number	Capacity	Std Pkg Qty
PMCS100	Up to 8 runs of MC/AC cable 0.43" – 0.56" in diameter	50

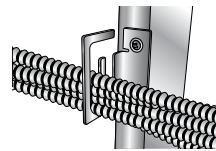

Flexible Cable Clip



- Push clip to attach MC or AC cable to metal stud
- No tools required for installation
- Provides fast installation

Part Number	Cable Size (in)	Std Pkg Qty
P449	12-2 (0.47 – 0.51 O.D.) 12-3 (0.49 – 0.54 O.D.) 14-2 (0.43 – 0.48 O.D.) 14-3 (0.46 – 0.50 O.D.)	100

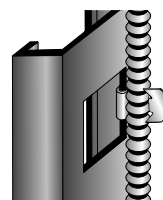

StrongHold™ Beam/Purlin

Screw-On Beam Clamps



- Attach to beam with screw
- Install with screwdriver, nut driver, or standard wrench
- Incorporate tapped holes to accommodate threaded rod

Part Number	Flange Thickness (in)	Tapped Hole	Static Load Rating (lbs)	Material	Std Pkg Qty
PBC*	Up to 1/2	1/4-20 in back and bottom; #10-24 in back	100	Spring Steel	100
PBC200		1/4-20 in back and bottom		Zinc Plated Steel	50
PBC400**	Up to 15/16	3/8-16 in back and bottom	200		25

*3/8" non-threaded clearance hole in top and bottom; 1/4" non-threaded clearance hole in back.
**UL and cUL listed.

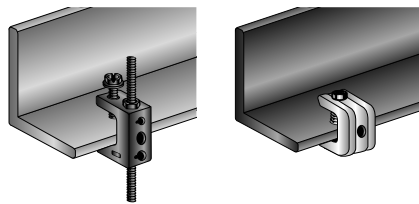

Hammer-On Beam Clamps with Attachment Tab



- Hammer-on installation
- Attachment tab provides 1/4" clearance hole for wire, S-hooks, or chain assemblies
- Static load capacity: 200 lbs.

Part Number	Flange Thickness (in)	Std Pkg Qty
P4H24	1/8 – 1/4	100
P4H58	5/16 – 1/2	

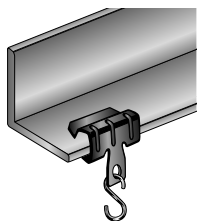

Hammer-On Beam Clamps



Image 1



Image 2

- Hammer-on installation
- Provided with a 1/4-20 thread so that boxes, fixtures, and bridle rings may be quickly and securely attached to the beam flanges (Image 1)
- Also available with 1/4-20 x 3/8" staked stud for easier attachment of outlet boxes to beams; eliminates need to use additional screws (Image 2)
- Static load capacity: 75 lbs.

Part Number	Image No.	Flange Thickness (in)	Std Pkg Qty
PM24	1	1/8 – 1/4	100
PM58		5/16 – 1/2	
PM24S	2	1/8 – 1/4	
PM58S		5/16 – 1/2	
PM912S		9/16 – 3/4	

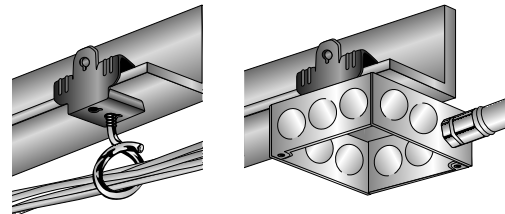

Reversible Beam Clamps



Image 1



Image 2

- Used when drop-rod length must be adjusted to accommodate a finished height in the field
- Jam nut included to prevent vibratory loosening
- Manufactured from malleable iron

Part Number	Image No.	Flange Thickness (in)	Threaded Hole	Std Pkg Qty
P3000037EG	1	3/4	3/8-16	25
PBC260025EG	2	1 1/4	1/4-20	50

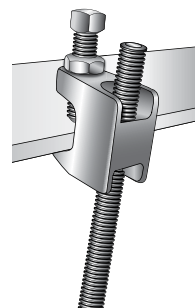

StrongHold™ Beam/Purlin

Hammer-On Beam Clamps with Rod Hanger



- Hammer-on beam clamps allow for easy installation
- Options available for threaded or non-threaded rod
- Options available for flanges 1/8" – 3/4" thick
- Static load capacity: 160 lbs.

Part Number	Flange Thickness (in)	Rod Size	Std Pkg Qty
P4TI24	1/8 – 1/4	1/4-20 threaded	100

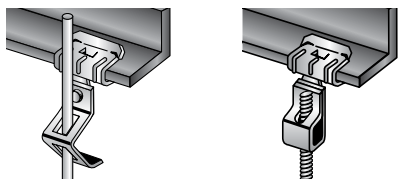

Spring Steel Screw-On Beam Clamp Assemblies



Image 1



Image 2

- Easily attach conduit to beams
- Can be installed on flange up to 1/2" thick
- Include snap-close or push-fit conduit fittings

Part Number	Image No.	Fits EMT (in)	Fits Rigid/IMC (in)	Static Load Rating (lbs)	Std Pkg Qty
PBC812M	1	1/2 – 3/4	1/2 – 3/4	100	100
PBC812MSM	2			25	

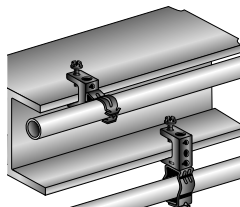

Rod and Wire Hangers with Bracket Supports



- Suspend #8 wire, 1/4", and 3/8" non-threaded or threaded rod from overhead mountings
- 1/4" clearance hole in right angle and offset brackets
- Static load capacity: 160 lbs.

Part Number	Rod Size	Bracket Orientation	Std Pkg Qty
P4TIB	1/4-20 threaded rod	Right Angle	100

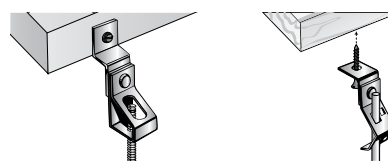

StrongHold™ Stud Wall Part Numbers

Electrical Box Mounting Support Brackets

Mount with self-tapping screws found on page 26

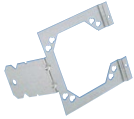

Image 1



Image 2

- Attach 4" or 4 11/16" electrical outlet boxes to studs
- Support feature reduces box movement in wall
- Manufactured from pre-galvanized steel
- Comply with NEC Article 300.4 (D) (reference pages O.1 for details)

Part Number	Image No.	Stud Depth (in)	Std Pkg Qty
PH23	1	2 1/2 and 3 1/2	100
PH4		2 1/2, 3 1/2, and 4	
PH6		6	
PMEB1	2	2 1/2, 3 1/2, and 4	25

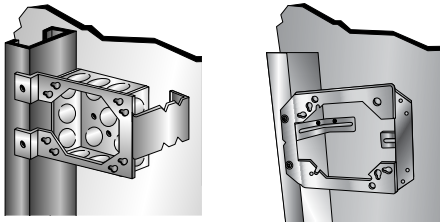

Screw-On Conduit Supports



Mount with self-tapping screws found on page 26

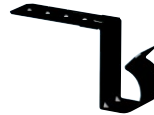

- Comply with NEC Article 358.30 to support conduit close to electrical box
- Accommodate EMT and MC/AC cable
- Allow conduit to align with box knockouts when used with PH series brackets (see page 24)

Part Number	Fits EMT (in)	Electrical Box Depth	Color	Std Pkg Qty
PCS16*	1	2 1/8	Black	100
PCS812	1/2 – 3/4	1 1/2		
PCS812D		2 1/8	Silver	

*Not UL or cUL listed.

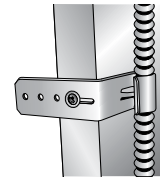

Press-On Nail Plate



- Fast installation; no tools required
- Protects electrical, datacom, and plumbing infrastructure
- Meets NEC Article 300.4 requirements (reference pages O.1 for details)

Part Number	Rod Size	Std Pkg Qty
P304B2	Press-on nail plate for wood or metal studs	100

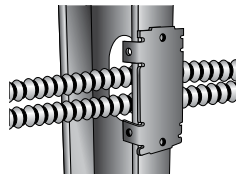

StrongHold™ Stud Wall

Far-Side Box Supports



Image 1



Image 2

- Clip to electrical box to utilize dry wall on far side of box for support
- Used with 1 1/2" or 2 1/8" deep electrical box
- Prevent electrical box from recessing into wall cavity
- No static load rating – for positioning only

Part Number	Image No.	Figure No.	Stud Depth (in)	Std Pkg Qty
PJ1A35	1	1	3 1/2	100

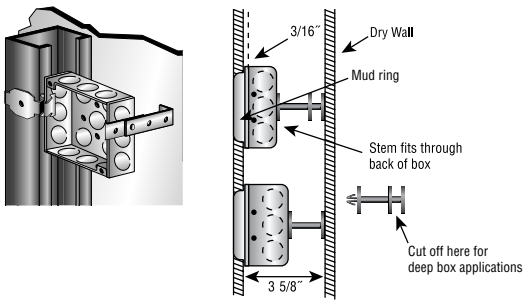

Adjustable Screw Gun Box Mounting Brackets

Mount with self-tapping screws found on page 26



- Adjustable to allow variability between stud spacing
- Utilized to mount electrical box between studs
- Suitable for 1 1/2" or 2 1/8" deep electrical boxes

Part Number	Description	Std Pkg Qty
PTSGB16	Mount box between studs spaced 11" – 18"	50
PTSGB24	Mount box between studs spaced 17" – 26"	

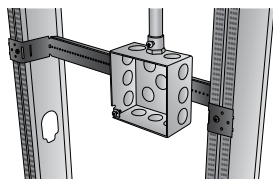

Rigid Box Mounting Brackets

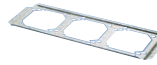

PRBS16



PRBS24

Mount with self-tapping screws found on page 26

- Used to secure multiple electrical boxes in stud walls
- Mount 1 1/2" or 2 1/8" deep electrical boxes
- Suitable for 4" or 4 11/16" wide electrical boxes

Part Number	Description	Std Pkg Qty
PRBS16	Rigid box mounting bracket for 16" stud spacing; capacity of three electrical boxes.	50
PRBS24*	Rigid box mounting bracket for 24" stud spacing; capacity of four electrical boxes.	25

*Not UL or cUL listed.

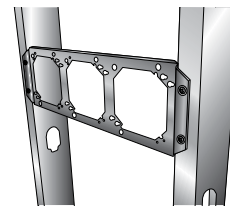

Floor-Mounted Box Bracket



Mount with self-tapping screws found on page 26



- Supports electrical box at consistent spacing from floor level
- Features can be used to prevent electrical box from being pushed into wall cavity
- Mounts 4" or 4 11/16" wide electrical boxes; 1 1/2" or 2 1/8" deep
- Meets ADA (Americans with Disabilities Act) accessibility guidelines/standards

Part Number	Description	Std Pkg Qty
PFMB18	Floor-mounted box bracket to mount center of electrical box 18" off floor.	25

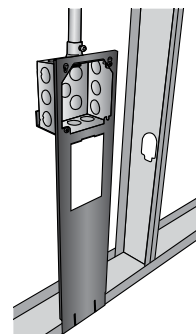

StrongHold™ Stud Wall

Anti-Rattle Bracket

Mount with self-tapping screws found on page 26



- Used as noise reduction and to stop rattling from Conduit, BX Cable, Armored Cable (EMT, MC/AC), or Rigid Conduit, when pulled through metal studs
- Attaches to metal stud with user supplied self-tapping screws
- Accommodates a variety of cable types up to 1" in diameter
- Meets ADA (Americans with Disabilities Act) accessibility guidelines/standards

Part Number	Description	Std Pkg Qty
SH781	Anti-rattle bracket for support of armored cable and conduit up to 1" in diameter, through metal stud wall.	100

Cable Support Clip



Mount with self-tapping screws found on page 26



- Used to maintain appropriate cable spacing behind dry wall to comply with NEC Article 300.4 (D) (reference pages O.1 – O.2 for details)
- Attaches to wood or metal stud with user-supplied screws
- Accommodates a variety of cable types

Part Number	Description	Std Pkg Qty
PCJ6	Cable support clip to provide 1 1/2" spacing for cables behind dry wall.	100

Cable Type	Cables Per Clip	Cable Size
Non-metallic	6	14-2, 12-2, 10-2, 14-3, 12-3, 10-3 with ground
Non-metallic	4	8-2, 6-2 with ground
MC/AC	4	14-2, 12-2, 10-2, 14-3, 12-3, 10-3, 14-4, 12-4, 10-4 with ground

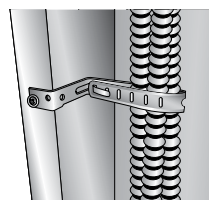

Cable Support Clip for Single Cable

Mount with self-tapping screws found on page 26



- Used to maintain appropriate cable spacing behind dry wall to comply with NEC Article 300.4 (D) (reference pages O.1 – O.2 for details)
- Provides 1 1/2" spacing for cables behind dry wall
- Attaches to wood or metal studs with hammer

Part Number	Description	Std Pkg Qty
PFXC20	Accommodates MC/AC cable (12-2 through 10-3).	100

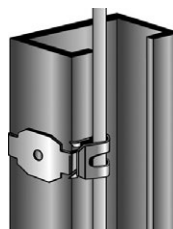

Metal Stud Grommets



MSG-1.3-C

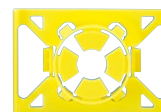

MSGV-1.3-C

- Install in pre-punched hole in metal studs
- Protect cable within the building structure

Part Number	Description	Std Pkg Qty
MSG-1.3-C	Metal stud grommet	100
MSGV-1.3-C	Metal stud grommet, anti-vibration tabs for 1/2" – 1" pipe	

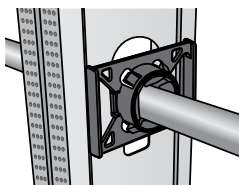

Self-Tapping Screw



- Used to secure StrongHold™ components to metal studs
- Low profile head utilizes #2 phillips head
- Packaging: plastic job jar

Part Number	Description	Std Pkg Qty
PSMS8	Metal stud punch tool	1000

StrongHold™ Communications/Low Voltage

J-Pro™ Series Referenced Images

- UL listed for use in plenum or air handling spaces (such as ceiling voids and underfloor areas) per NEC Article 300.22 (C) and (D) (reference pages O.2 – O.4 for details)
- Complete horizontal and vertical 1" bend radius control

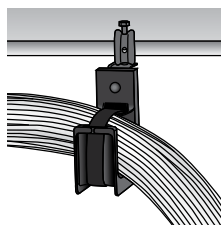

Available colors can be found on page 29

For small to medium business requirements, Panduit also offers NetKey® Copper and Fiber Cabling System. NetKey® is a complete standards compliant cabling infrastructure solution for voice, data and video applications.

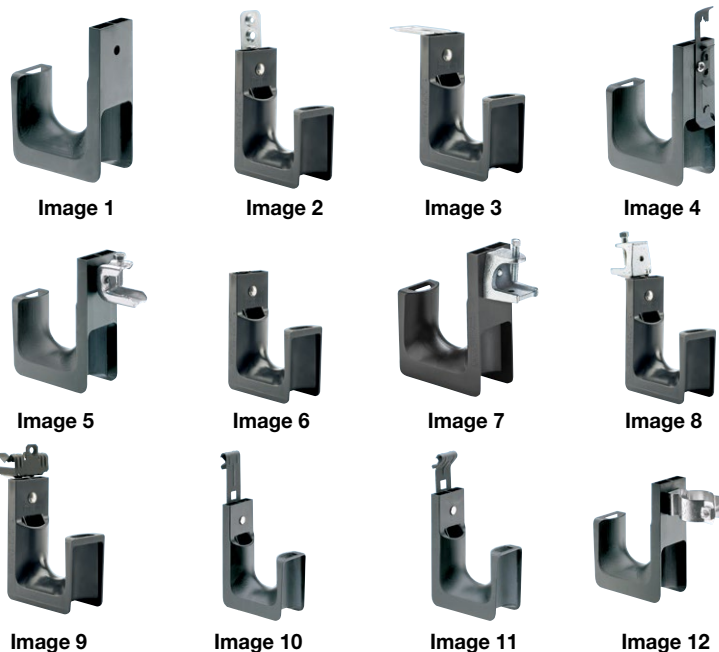

J-Pro™ JP75 Series

- Bundle capacity: 3/4"
- Cable capacity: Category 6A (5), Category 6A (SD) (8), Category 6 (8), Category 5e (10)

Part Number	Image No.	Description	Std Pkg Qty
JP75W-L20	1	Wall mount – one 1/4" mounting hole	50
JP75WP2B-L20	2	Wall mount for powder actuated fasteners – one 5/32" and one 1/4" mounting hole	
JP75CMB-L20	3	Ceiling mount – 3/16", 1/4", and 3/8" mounting holes	
JP75DW-L20	4	Drop wire and threaded rod clip mount	
JP75SBC50-L20	5	Screw-on beam clamp mount – up to 1/2" flange	
JP75SBC50RB-L20	6	Screw-on beam clamp mount – up to 1/2" flange. Rotates 360°	
JP75SBC87-L20	7	Screw-on beam clamp mount – up to 3/4" flange	
JP75SBC87RB-L20	8	Screw-on beam clamp mount – up to 3/4" flange. Rotates 360°	
JP75HBC25RB-L20	9	Hammer-on beam clamp mount – 1/8" - 1/4" flange. Rotates 360°	
JP75HBC50RB-L20		Hammer-on beam clamp mount – 5/16" – 1/2" flange. Rotates 360°	
JP75HBC75RB-L20		Hammer-on beam clamp mount – 9/16" – 3/4" flange. Rotates 360°	
JP75CP-L20	10	C-purlin clips for straight flanges up to 1/4" thick	
JP75ZP-L20	11	Z-purlin clips for angled flanges up to 1/4" thick	
JP75UF100-L20	12	Underfloor pedestal support clip for pedestal 7/8" square or 1 1/8" – 1 3/8" in diameter	

J-Pro™ JP131 Series

- Bundle capacity: 1 5/6"
- Cable capacity: Category 6A (15), Category 6A (SD) (25), Category 6 (25), Category 5e (29)

Part Number	Image No.	Description	Std Pkg Qty
JP131W-L20	1	Wall mount – one 1/4" mounting hole	50
JP131WP2B-L20	2	Wall mount for powder actuated fasteners – one 5/32" and one 1/4" mounting hole	
JP131CMB-L20	3	Ceiling mount – 3/16", 1/4", and 3/8" mounting holes	
JP131DW-L20	4	Drop wire and threaded rod clip mount	
JP131SBC50-L20	5	Screw-on beam clamp mount – up to 1/2" flange	
JP131SBC50RBL20	6	Screw-on beam clamp mount – up to 1/2" flange. Rotates 360°	
JP131SBC87-L20	7	Screw-on beam clamp mount – up to 3/4" flange	
JP131SBC87RBL20	8	Screw-on beam clamp mount – up to 3/4" flange. Rotates 360°	
JP131HBC25RBL20	9	Hammer-on beam clamp mount – 1/8" – 1/4" flange. Rotates 360°	
JP131HBC50RBL20		Hammer-on beam clamp mount – 5/16" – 1/2" flange. Rotates 360°	
JP131HBC75RBL20		Hammer-on beam clamp mount – 9/16" – 3/4" flange. Rotates 360°	
JP131CP-L20	10	C-purlin clips for straight flanges up to 1/4" thick	
JP131ZP-L20	11	Z-purlin clips for angled flanges up to 1/4" thick	
JP131UF100-L20	12	Underfloor pedestal support clip for pedestal 7/8" square or 1 1/8" – 1 3/8" in diameter	

StrongHold™ Communications/Low Voltage

J-Pro™ Extension Bracket



- Compatible with 3/4", 1 5/16", and 2" J-Pro™ products
- Allows multiple hooks to be installed utilizing one attachment point
- Includes 1/8", 1/4", and 3/8" mounting holes for various user-supplied hardware

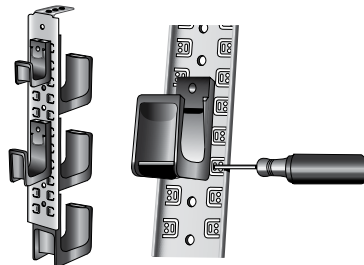

Part Number	Description	Std Pkg Qty
PCATHBA	Multi-tier bracket for J-Pro™ product line.	10

1

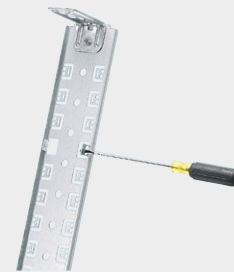

Bend appropriate tabs with flathead screwdriver to prevent intended hook from rotating once installed.

J-Pro™ JP2 Series

- Bundle capacity: 2"
- Cable capacity: Category 6A (30), Category 6A (SD) (46), Category 6 (46), Category 5e (55)

Part Number	Image No.	Description	Std Pkg Qty
JP2W-L20	1	Wall mount – one 1/4" mounting hole.	50
JP2WP2B-L20	2	Wall mount for powder actuated fasteners – one 5/32" and one 1/4" mounting hole.	
JP2CMB-L20	3	Ceiling mount – 3/16", 1/4", and 3/8" mounting holes.	
JP2DW-L20	4	Drop wire and threaded rod clip mount.	
JP2SBC50-L20	5	Screw-on beam clamp mount – up to 1/2" flange.	
JP2SBC50RB-L20	6	Screw-on beam clamp mount – up to 1/2" flange. Rotates 360°.	
JP2SBC87-L20	7	Screw-on beam clamp mount – up to 3/4" flange.	
JP2SBC87RB-L20	8	Screw-on beam clamp mount – up to 3/4" flange. Rotates 360°.	
JP2HBC25RB-L20	9	Hammer-on beam clamp mount – 1/8" – 1/4" flange. Rotates 360°.	
JP2HBC50RB-L20		Hammer-on beam clamp mount – 5/16" – 1/2" flange. Rotates 360°.	
JP2HBC75RB-L20		Hammer-on beam clamp mount – 9/16" – 3/4" flange. Rotates 360°.	
JP2CP-L20	10	C-purlin clips for straight flanges up to 1/4" thick.	
JP2ZP-L20	11	Z-purlin clips for angled flanges up to 1/4" thick.	
JP2UF100-L20	12	Underfloor pedestal support clip for pedestal 7/8" square or 1 1/8" – 1 3/8" in diameter.	

2



Install appropriate J-Pro™ wall-mounted hook with user-supplied hardware.

3



To mount additional hooks to the same bracket, bend the appropriate tabs with flathead screwdriver to prevent hook from rotating once installed.

J-Pro™ JP4 Series

- Bundle capacity: 4"
- Cable capacity: Category 6A (115), Category 6A (SD) (180), Category 6 (180), Category 5e (200)

Part Number	Image No.	Description	Std Pkg Qty
JP4W-X20	1	Wall mount – one 1/4" mounting hole.	10
JP4WP2B-X20	2	Wall mount for powder actuated fasteners – one 5/32" and one 1/4" mounting hole.	
JP4CMB-X20	3	Ceiling mount – 3/16", 1/4", and 3/8" mounting holes.	
JP4SBC50-X20	5	Screw-on beam clamp mount – up to 1/2" flange.	
JP4SBC50RB-X20	6	Screw-on beam clamp mount – up to 1/2" flange. Rotates 360°.	
JP4SBC87-X20	7	Screw-on beam clamp mount – up to 3/4" flange.	
JP4SBC87RB-X20	8	Screw-on beam clamp mount – up to 3/4" flange. Rotates 360°.	
JP4HBC25RB-X20	9	Hammer-on beam clamp mount – 1/8" – 1/4" flange. Rotates 360°.	
JP4HBC50RB-X20		Hammer-on beam clamp mount – 5/16" – 1/2" flange. Rotates 360°.	
JP4HBC75RB-X20		Hammer-on beam clamp mount – 9/16" – 3/4" flange. Rotates 360°.	
JP4ZP-X20	11	Z-purlin clips for angled flanges up to 1/4" thick.	
JP4UF100-X20	12	Underfloor pedestal support clip for pedestal 7/8" square or 1 1/8" – 1 3/8" in diameter.	

4



Install additional J-Pro™ wall-mounted hook with user-supplied hardware.

StrongHold™ Communications/Low Voltage

J-Pro™ Color Selection Guide

Base Part Number	Black	Red	Blue	White	Green	Orange
JP75W		-L2				-L3
JP75WP2B						
JP75CMB						
JP75DW		-L2				
JP75ZP						
JP75CP						
JP75SBC50						
JP75SBC87						
JP75SBC50RB						
JP75SBC87RB						
JP75HBC25RB						
JP75HBC50RB		-L2				
JP75HBC75RB						
JP75UF100						
JP131W			-L6		-L5	
JP131WP2B						
JP131CMB						
JP131DW						
JP131ZP						
JP131CP						
JP131SBC50	-L20					
JP131SBC87						
JP131SBC50RB				-L		
JP131SBC87RB						
JP131HBC25RB						
JP131HBC50RB		-L2				
JP131HBC75RB						
JP131UF100						
JP2W		-L2	-L6	-L	-L5	-L3
JP2WP2B						
JP2CMB						
JP2DW		-L2	-L6	-L		
JP2ZP						
JP2CP						
JP2SBC50				-L		
JP2SBC87						
JP2SBC50RB						
JP2SBC87RB						
JP2HBC25RB						
JP2HBC50RB						
JP2HBC75RB						
JP2UF100						
JP4W				-X		
JP4WP2B						
JP4CMB						
JP4ZP						
JP4CP						
JP4SBC50						
JP4SBC87	-X20					
JP4SBC50RB				-X		
JP4SBC87RB						
JP4HBC25RB						
JP4HBC50RB						
JP4HBC75RB						
JP4UF100						

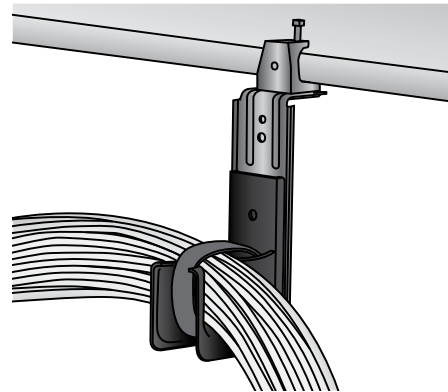

Panduit offers a variety of Hook & Loop Tak-Tys that compliment our J-Mod Communications supports. For more information visit: www.panduit.com

Additional colors available, contact your local sales representative or go to www.panduit.com for availability.

Order number of pieces required, in multiples of standard package quantity.

StrongHold™ Communications/Low Voltage

J-Mod® Series Referenced Images

- UL listed for use in plenum or air handling spaces (such as ceiling voids and underfloor areas) per NEC Article 300.22 (C) and (D) (reference pages O.2 – O.4 for details)
- Complete horizontal and vertical 1" bend radius control



Image 1



Image 2

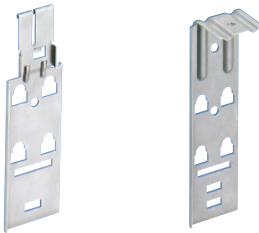

Image 3



Image 4



Image 5



Image 6



Image 7



Image 8



Image 9

J-Mod® Series

- Bundle capacity: 2"
- Cable capacity: Category 6A (30), Category 6A (SD) (46), Category 6 (46), Category 5e (55)

Part Number	Image No.	Description	Std Pkg Qty
JMJDW-X20	1	J-hook for wall mount applications only; two 1/4" mounting holes for user supplied screws.	10
JMJDH-X20	2	J-hook for use with J-Mod® brackets.	
JMJDH-X	3	Chaining bracket to extend existing J-Mod® capacity; for use with single-level mounting brackets; three levels maximum.	
JMJDH25-1-X	4	Single-level ceiling mount bracket with one 1/4" mounting hole.	
JMJDH25-3-X	5	Three-level ceiling mount bracket with one 1/4" mounting hole.	
JMJDWB-1-X	6	Single-level drop wire bracket that attaches to #12 wire or 1/4" threaded rod.	
JMJDWB38-3-X	7	Three-level threaded rod bracket; accepts 1/4" – 3/8" threaded rod.	
JMJDWB87-1-X	8	Single-level screw-on beam clamp bracket for use with flanges up to 3/4" thick.	
JMJDWB87-3-X	9	Three-level screw-on beam clamp bracket for use with flanges up to 3/4" thick.	

Panduit offers a variety of Hook & Loop Tak-Tys that compliment our J-Mod Communications supports. For more information visit: www.panduit.com

J-Mod® Series Installation Instructions

1

Align snap lock attachment of J-hook with holes in chosen bracket and snap J-hook into place.

2

Align chaining bracket under the assembly.

3

Slide chaining bracket between J-hook and the metal bracket until it snaps.

4

Pull down to fully engage.

5

Attach J-hooks as explained in first-level installation above.

6

Final assembly is a second-level installation consisting of one threaded rod bracket, one chaining bracket, and two J-hooks for clarity.

StrongHold™ Communications/Low Voltage

Bridle Rings Referenced Images



Image 1



Image 2



Image 3



Image 4



Image 5

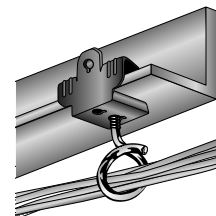

Bridle Rings

- Suitable for low-voltage cabling
- Not suitable for high-performance communication cabling
- Variety of mounting options available to support specific application requirements



Bridle Rings with Saddles



Image 1

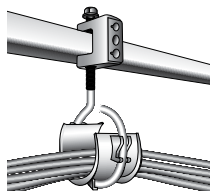

Image 2

- Plastic saddles allow bridle rings to be used for communication cable
- Suitable for use in air handling spaces
- Available pre-installed or can be ordered separately to be installed by the user

Part Number	Image No.	Description	Std Pkg Qty
BR-1.25-1/4-20	1	1 1/4" capacity – mounts with 1/4"-20 threads.	100
BR-2.0-1/4-20		2" capacity – mounts with 1/4"-20 threads.	
BR-4.0-1/4-20		4" capacity – mounts with 1/4"-20 threads.	
BR-2.0-14WS	2	2" capacity – mounts with #14 wood screw thread.	100
BR-1.5-PAF	3	1 1/2" capacity – mounts with powder actuated fastener.	50
BR-2.0-PAF		2" capacity – mounts with powder actuated fastener.	50
BR-1.5-SN	4	1 1/2" capacity – mounts with screws, nails, or other user supplied fasteners.	100

Part Number	Image No.	Description	Std Pkg Qty
BR-1.5-1/4-20S	1	Bridle ring with saddle – 1.5" capacity – mounts with 1/4-20 threads.	50
BR-2.0-1/4-20S		Bridle ring with saddle – 2" capacity – mounts with 1/4-20 threads.	
BR-4.0-1/4-20S		Bridle ring with saddle – 4" capacity – mounts with 1/4-20 threads.	



Stronghold™ Dry Wall

Low-Voltage Mounting Brackets



Image 1

Image 2

Image 3

Mount with self-tapping screws found on page 26

- Choose design styles for new or retrofit installations
- Available in both single and double gang configurations
- Manufactured from galvanized steel materials

Part Number	Image No.	Description	Std Pkg Qty
LV-S-1G	1	Single gang, low-voltage mounting bracket for new installations.	25
LV-W-1G	2	Single gang, low-voltage mounting bracket for retrofit installations; suitable for wall material thicknesses for 1/2" – 1 1/2".	100
LV-W-2G	3	Double gang, low-voltage mounting bracket for retrofit installations; suitable for wall material thicknesses for 1/2" – 1 1/2".	50



Old Work Box Mount

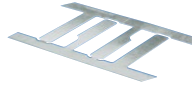

- Prevents electrical box from pulling away from dry wall
- Supports box to dry wall to prevent mounting directly to stud
- Allows quick installation with no tools required
- Manufactured from pre-galvanized steel

Part Number	Description	Std Pkg Qty
PDSI2A	Secures electrical box to dry wall.	100

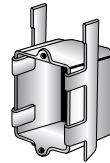

Wiring Device Retainer

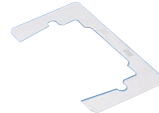

- Provides stability and prevents broken cover plates
- Manufactured from pre-galvanized steel

Part Number	Description	Std Pkg Qty
PRLC	Mounts standard outlet or switch in oversized openings	100

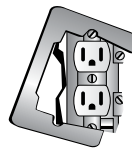

StrongHold™ Acoustical

Troffer Fastener Clip



- Positive clip-on support for troffers/lay-in fixtures
- Fits round or rectangular head T-bars
- Complies with NEC Article 410.36 requirements (reference pages O.11 for details)
- For upturned or straight lip fixtures

Part Number	Description	Std Pkg Qty
P515A	T-bar clip for troffers	100

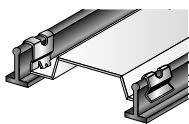

Heavy Duty Adjustable Box Mounting Bar Hangers



P512HDK

- Box fastener adjustable for 16" – 24" ceiling joist/stud spacing
- Allow versatility in installing electrical boxes along the length of the bar
- Install quickly and easily between ceiling joists or wall studs

Part Number	Description	Std Pkg Qty
P512HDK	Installs in 1/2" knockouts in bottom of electrical box.	50

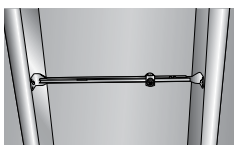

Box to T-Bar Fasteners



Image 1



Image 2



Image 3



Image 4

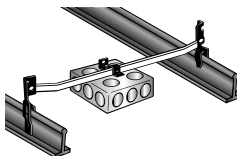

Image 5

- Accommodate 24" T-bar span
- Non-adjustable version is suitable for flush or offset mount
- Adjustable version provides for 8" adjustments allowing the installation of double deep boxes, speaker cases, and emergency light fixtures above T-bar

Part Number	Image No.	Description	Std Pkg Qty
P512	1	Box to T-bar fastener for flush or 3/4" offset mount	50
P512A	2	Box to T-bar fastener allows up to 8" of height adjustment	25
PBHC*	3	Additional box mounting clip with screw for P512 and P512A	100
P512HD	4	Heavy duty box to t-bar fastener for 24" span. Includes box mounting clip	25
P510HD	5	Additional box mounting clip for P512HD	100

*Not UL or cUL listed.



Twist-On T-Bar Hanger



- Easily twists onto T-bar to support electrical fixtures
- Accommodates T-bar 15/16" wide
- Includes 1" wing nut washer

Part Number	Description	Static Load Rating (lbs)	Std Pkg Qty
P4G16	Twist-on T-bar hanger with 1/4-20 x 5/8" long threaded stud.	50	100

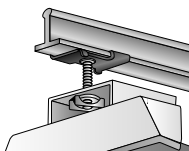

StrongHold™ Convenient Sizing Information

Electrical Metallic Tubing (EMT)

Trade Size (in)	Nominal Inside Dia.* (in)	Nominal Outside Dia. (in)	Min. Weight Per 100 Ft. w/Couplings Attached (lbs)	Weight of Conduit and Conductors Per 100 Ft. (lbs)
0.38	0.49	0.58	23.00	36.60
0.50	0.62	0.71	28.50	50.60
0.75	0.82	0.92	43.50	84.30
1.00	1.05	1.16	64.00	130.30
1.25	1.38	1.51	95.00	212.30
1.50	1.61	1.74	110.00	269.80
2.00	2.07	2.20	140.00	401.80
2.50	2.73	2.88	205.00	579.00
3.00	3.36	3.50	250.00	826.30
3.50	3.83	4.00	325.00	1098.00
4.00	4.33	4.50	370.00	1364.00

*Per UL table NAE.3.

Rigid Steel Conduit

Trade Size (in)	Nominal Inside Dia.* (in)	Nominal Outside Dia. (in)	Min. Weight Per 100 Ft. w/ Couplings Attached (lbs)	Weight of Conduit and Conductors Per 100 Ft. (lbs)
0.38	0.49	0.68	51.50	65.10
0.50	0.63	0.84	79.00	101.00
0.75	0.84	1.05	105.00	145.80
1.00	1.06	1.32	153.00	219.30
1.25	1.39	1.66	201.00	318.30
1.50	1.62	1.90	249.00	408.80
2.00	2.08	2.38	332.00	593.80
2.50	2.49	2.88	527.00	901.00
3.00	3.09	3.50	682.60	1259.00
3.50	3.57	4.00	831.00	1604.00
4.00	4.05	4.50	972.30	1967.00

*Per UL table NAE.3.

Intermediate Metal Conduit (IMC)

Trade Size (in)	Nominal Inside Dia.* (in)	Nominal Outside Dia. (in)	Min. Weight Per 100 Ft. w/ Couplings Attached (lbs)	Weight of Conduit and Conductors Per 100 Ft. (lbs)
0.50	0.68	0.82	60.00	82.10
0.75	0.88	1.03	82.00	122.80
1.00	1.12	1.29	116.00	182.30
1.25	1.47	1.64	150.00	267.30
1.50	1.70	1.88	182.00	341.80
2.00	2.17	2.36	242.00	503.80
2.50	2.60	2.86	401.00	775.00
3.00	3.22	3.48	493.00	1069.00
3.50	3.71	3.97	573.00	1346.00
4.00	4.21	4.47	638.00	1632.00

*Per UL table NAE.3.

Rigid Aluminum Conduit

Trade Size (in)	Nominal Inside Dia.* (in)	Nominal Outside Dia. (in)	Min. Weight Per 100 Ft. w/Couplings Attached (lbs)	Weight of Conduit and Conductors Per 100 Ft. (lbs)
0.50	0.63	0.84	27.40	49.50
0.75	0.84	1.05	36.40	77.20
1.00	1.06	1.32	53.00	119.30
1.25	1.39	1.66	69.60	186.90
1.50	1.62	1.90	82.20	242.00
2.00	2.08	2.38	115.70	377.50
2.50	2.49	2.88	182.50	556.50
3.00	3.09	3.50	238.90	815.20
3.50	3.57	4.00	287.70	1061.00
4.00	4.05	4.50	340.00	1334.00
5.00	5.07	5.56	465.40	2028.00
6.00	6.09	6.63	612.50	2870.00

*Per UL table NAE.3.

Schedule 40 PVC Plastic Pipe

Nominal Pipe Size (in)	Outside Diameter (in)	Wall Thickness (in)	Weight of Pipe Per Ft. (lbs)	Weight of Water Per Ft. (lbs)
0.13	0.41	0.07	0.04	0.02
0.25	0.54	0.09	0.07	0.04
0.38	0.68	0.09	0.10	0.08
0.50	0.84	0.11	0.15	0.1
0.75	1.05	0.11	0.20	0.20
1.00	1.32	0.13	0.30	0.40
1.25	1.66	0.14	0.40	0.60
1.50	1.90	0.15	0.50	0.90
2.00	2.38	0.15	0.60	1.40
2.50	2.88	0.20	1.00	2.10
3.00	3.50	0.22	1.30	3.20
3.50	4.00	0.23	1.60	4.30
4.00	4.50	0.24	1.90	5.50

J-Pro™ Capacity

J-Pro™ Family	Category 6A (0.300")	Category 6A (SD) (0.240")	Category 6 (0.240")	Category 5e (0.225")
JP75	5	8	8	10
JP131	15	25	25	29
JP2	30	46	46	55
JP4	115	180	180	200

Note: The above cable diameters represent the nominal Panduit cable diameter per performance level. For specific cable fill information based on specific part numbers, please contact customer service.

Electrical Non-Metallic Tubing (ENT)

Trade Nominal Size (in)	Nominal Inside Dia.* (in)	Nominal Outside Dia. (in)	Min. Weight of Conduit Per 100 Ft. (lbs)	Weight of Conduit and Conductors Per 100 Ft. (lbs)
0.50	0.56	0.84	11.00	33.10
0.75	0.76	1.05	14.00	54.80
1.00	1.00	1.32	20.00	86.30
1.25	1.40	1.66	19.00	136.30
1.50	1.55	1.99	27.00	186.80
2.00	2.03	2.38	32.00	261.80

*Per UL table NAE.3.

Type THHN – Insulated Single Conductor Building Wire

Size (AWG)	Armor Outside Dia. (in)	Approximate Weight Per 100 Ft. (lbs)
14	0.11	1.70
12	0.13	2.50
10	0.16	4.00
8	0.22	6.50
6	0.25	9.70
4	0.32	15.50
3	0.35	19.10
2	0.38	23.60
1	0.45	30.40
1/0	0.49	37.50

StrongHold™ Convenient Sizing Information

All Threaded Rod (ATR)

Nominal Size and Thread	Root Area		Design Load SF = 5	
	in ²	cm ²	lbs	kN
1/4-20	0.03	0.17	240.00	1.07
5/16-18	0.05	0.29	400.00	1.78
3/8-16	0.07	0.44	610.00	2.71

Communication Cable

CableType	Diameter (in)
Category 6A	0.300
Category 6A (SD)	0.240
Category 6	0.240
Category 5e	0.225

MC Cable

AWG Size	Insulated Ground Nominal Outside Dia. (in)	Bare Ground Nominal Outside Dia. (in)
14-2 Solid	0.45	0.43
14-3 Solid	0.48	0.44
14-4 Solid	0.51	0.49
12-2 Solid	0.50	0.47
12-3 Solid	0.53	0.50
12-4 Solid	0.57	0.56
10-2 Solid	0.56	0.52
10-3 Solid	0.60	0.55
10-4 Solid	0.65	0.62
8-2 Stranded	0.71	0.68
8-3 Stranded	0.77	0.71
8-4 Stranded	0.84	0.77
6-2 Stranded	0.80	0.76
6-3 Stranded	0.87	0.80
6-4 Stranded	0.95	0.87
4-2 Stranded	0.95	0.90
4-3 Stranded	1.04	0.95
4-4 Stranded	1.14	1.10
2-2 Stranded	1.08	1.01
2-3 Stranded	1.18	1.08
2-4 Stranded	1.30	1.18

Type NM – Non-Metallic Sheathed Cable

AWG Size	No. of Strands	Ground Wire Size	Approximate Outside Dia. (in)	Approximate Weight Per 100 Ft. (lbs)
Without Ground Wire				
14-2	Solid	-	0.17 x 0.37	5.30
12-2			0.19 x 0.40	7.00
10-2			0.22 x 0.45	10.10
14-3			0.30	8.20
12-3			0.33	10.90
10-3			0.40	15.70
8-3	7		0.54	27.80
6-3			0.61	42.20
With Ground Wire				
14-2	Solid	14	0.17 x 0.37	6.40
12-2		12	0.19 x 0.41	9.00
10-2		10	0.22 x 0.49	13.30
8-2	7	10	0.28 x 0.61	21.50
6-2		10	0.32 x 0.73	31.30
14-3	Solid	14	0.32	9.30
12-3		12	0.36	12.90
10-3		10	0.44	18.70
14-4		14	0.45	11.60
12-4		12	0.49	16.10
10-4		10	0.55	23.30
8-3	7	10	0.55	30.50
6-3			0.61	45.00
4-3		8	0.82	66.40
2-3			0.95	93.00

AC Cable

Type of Armored Cable	Type of Circuit Conductors	AWG Size of Circuit Conductors	Minimum		External Diameter of Armor					
			Cable with Two Circuit Conductors and No Grounding Conductor (in)		Cable with Three Circuit Conductors and No Grounding Conductor, and Cable with Two Circuit Conductors and a Grounding Conductor (in)		Cable with Four Circuit Conductors and No Grounding Conductor, and Cable with Three Circuit Conductors and a Grounding Conductor (in)		Cable with Four Circuit Conductors and a Grounding Conductor (in)	
			Solid	Stranded	Solid	Stranded	Solid	Stranded	Solid	Stranded
ACTMM	THHN	14	0.43	—	0.45	—	0.49	—	0.52	—
		12	0.48	—	0.49	—	0.52	—	0.55	—
		10	0.48	—	0.50	—	0.54	—	0.59	—
		8	0.57	0.60	0.60	0.64	0.65	0.70	0.71	0.76
		6	—	0.70	—	0.74	—	0.81	—	0.88
		4	—	0.84	—	0.89	—	0.97	—	1.07
		2	—	0.96	—	1.01	—	1.12	—	1.23

StrongHold™ Codes and Standards

NFPA 70; National Electric Code; 2014 Revision

90.4 Enforcement. This Code is intended to be suitable for mandatory application by governmental bodies that exercise legal jurisdiction over electrical installations, including signaling and communications systems, and for use by insurance inspectors. The authority having jurisdiction for enforcement of the Code has the responsibility for making interpretations of the rules, for deciding on the approval of equipment and materials, and for granting the special permission contemplated in a number of the rules. By special permission, the authority having jurisdiction may waive specific requirements in this Code or permit alternative methods where it is assured that equivalent objectives can be achieved by establishing and maintaining effective safety.

This Code may require new products, constructions, or materials that may not yet be available at the time the Code is adopted. In such event, the authority having jurisdiction may permit the use of the products, constructions, or materials that comply with the most recent previous edition of this Code adopted by the jurisdiction.

300.4 Protection Against Physical Damage.**(B) Nonmetallic-Sheathed Cables and Electrical Nonmetallic****Tubing through Metal Framing Members.**

(1) Nonmetallic-Sheathed Cable. In both exposed and concealed locations where nonmetallic-sheathed cables pass through either factory- or field-punched, cut, or drilled slots or holes in metal members, the cable shall be protected by listed bushings or listed grommets covering all metal edges that are securely fastened in the opening prior to installation of the cable.

(D) Cables and Raceways Parallel to Framing Members and Furring

Strips. In both exposed and concealed locations, where a cable- or raceway-type wiring method is installed parallel to framing members, such as joists, rafters, or studs, or is installed parallel to furring strips, the cable or raceway shall be installed and supported so that the nearest outside surface of the cable or raceway is not less than 32mm (1 1/4 in.) from the nearest edge of the framing member or furring strips where nails or screws are likely to penetrate. Where this distance cannot be maintained, the cable or raceway shall be protected from penetration by nails or screws by a steel plate, sleeve, or equivalent at least 1.6mm (1/16 in.) thick.

Exception No. 1: Steel plates, sleeves, or the equivalent shall not be required to protect rigid metal conduit, intermediate metal conduit, rigid nonmetallic conduit, or electrical metallic tubing.

Exception No. 2: For concealed work in finished buildings, or finished panels for prefabricated buildings where such supporting is impracticable, it shall be permissible to fish the cables between access points. Exception No. 3: A listed and marked steel plate less than 1.6mm (1/16 in.) thick that provides equal or better protection against nail or screw penetration shall be permitted.

300.11 Securing and Supporting.

(A) Secured in Place. Raceways, cable assemblies, boxes, cabinets, and fittings shall be securely fastened in place. Support wires that do not provide secure support shall not be permitted as the sole support. Support wires and associated fittings that provide secure support and that are installed in addition to the ceiling grid support wires shall be permitted as the sole support. Where independent support wires are used, they shall be secured at both ends. Cables and raceways shall not be supported by ceiling grids.

(1) Fire-Rated Assemblies. Wiring located within the cavity of a fire-rated floor-ceiling or roof-ceiling assembly shall not be secured to, or supported by, the ceiling assembly, including the ceiling support wires. An independent means of secure support shall be provided and shall be permitted to be attached to the assembly. Where independent support wires are used, they shall be distinguishable by color, tagging, or other effective means from those that are part of the fire-rated design.

Exception: The ceiling support system shall be permitted to support wiring and equipment that have been tested as part of the fire-rated assembly.

Informational Note: One method of determining fire rating is testing in accordance with ANSI/ASTM E119-2012a, Method for Fire Tests of Building Construction and Materials.

(2) Non-Fire-Rated Assemblies. Wiring located within the cavity of a non-fire-rated floor-ceiling or roof-ceiling assembly shall not be secured to, or supported by, the ceiling assembly, including the ceiling support wires. An independent means of secure support shall be provided and shall be permitted to be attached to the assembly. Where independent support wires are used, they shall be distinguishable by color, tagging, or other effective means.

Exception: The ceiling support system shall be permitted to support branch-circuit wiring and associated equipment where installed in accordance with the ceiling system manufacturer's instructions.

300.22 Wiring in Ducts not used for Air Handling, Fabricated Ducts for Environmental Air, and other Spaces for Environmental Air (Plenums). The provisions of this section shall apply to the installation and uses of electrical wiring and equipment in ducts used for dust, loose stock, or vapor removal; ducts specifically fabricated for environmental air; and other spaces used for environmental air (plenums).

Informational Note: See Article 424, Part VI, for duct heaters.

(A) Ducts for Dust, Loose Stock, or Vapor Removal. No wiring systems of any type shall be installed in ducts used to transport dust, loose stock, or flammable vapors. No wiring system of any type shall be installed in any duct, or shaft containing only such ducts, used for vapor removal or for ventilation of commercial-type cooking equipment.

(B) Ducts Specifically Fabricated for Environmental Air. Equipment, devices and the wiring methods specified in this section shall be permitted within such ducts only if necessary for the direct action upon, or sensing of, the contained air. Where equipment or devices are installed and illumination is necessary to facilitate maintenance and repair, enclosed gasketed-type luminaires shall be permitted.

Only wiring methods consisting of Type MI cable without an overall nonmetallic covering, Type MC cable employing a smooth or corrugated impervious metal sheath without an overall nonmetallic covering, electrical metallic tubing, flexible metallic tubing, intermediate metal conduit, or rigid metal conduit without an overall nonmetallic covering shall be installed in ducts specifically fabricated to transport environmental air. Flexible metal conduit shall be permitted, in lengths not to exceed 1.2m (4 ft.), to connect physically adjustable equipment and devices permitted to be in these fabricated ducts. The connectors used with flexible metal conduit shall effectively close any openings in the connection.

C) Other Spaces Used for Environmental Air (Plenums).

This section shall apply to spaces not specifically fabricated for environmental air-handling purposes but used for air-handling purposes as a plenum. This section shall not apply to habitable rooms or areas of buildings, the prime purpose of which is not air handling.

Informational Note No. 1: The space over a hung ceiling used for environmental air-handling purposes is an example of the type of other space to which this section applies.

Informational Note No. 2: The phrase "Other Spaces Used for Environmental Air (Plenum)" as used in this section correlates with the use of the term "plenum" in NFPA 90A-2012, Standard for the Installation of Air-Conditioning and Ventilating Systems, and other mechanical codes where the plenum is used for return air purposes, as well as some other air-handling spaces.

Exception: This section shall not apply to the joist or stud spaces of dwelling units where the wiring passes through such spaces perpendicular to the long dimension of such spaces.

(1) Wiring Methods. The wiring methods for such other space shall be limited to totally enclosed, nonventilated, insulated busway having no provisions for plug-in connections, Type MI cable without an overall nonmetallic covering, Type MC cable without an overall nonmetallic covering, Type AC cable, or other factory-assembled multiconductor

StrongHold™ Codes and Standards

control or power cable that is specifically listed for use within an air-handling space, or listed prefabricated cable assemblies of metallic manufactured wiring systems without nonmetallic sheath. Other types of cables, conductors, and raceways shall be permitted to be installed in electrical metallic tubing, flexible metallic tubing, intermediate metal conduit, rigid metal conduit without an overall nonmetallic covering, flexible metal conduit, or, where accessible, surface metal raceway or metal wireway with metal covers. Nonmetallic cable ties and other nonmetallic cable accessories used to secure and support cables shall be listed as having low smoke and heat release properties.

Informational Note: One method to determine low smoke and heat release properties is that the nonmetallic cable ties and other nonmetallic cable accessories exhibit a maximum peak optical density of 0.50 or less, an average optical density of 0.15 or less, and a peak heat release rate of 100kW or less when tested in accordance with ANSI/UL 2043-2008, Fire Test for Heat and Visible Smoke Release for Discrete Products and Their Accessories Installed in Air-Handling Spaces.

2) Cable Tray Systems. The provisions in (a) or (b) shall apply to the use of metallic cable tray systems in other spaces used for environmental air (plenums), where accessible, as follows:

- (a) **Metal Cable Tray Systems.** Metal cable tray systems shall be permitted to support the wiring methods in 300.22 (C)(1).
- (b) **Solid Side and Bottom Metal Cable Tray Systems.**

Solid side and bottom metal cable tray systems with solid metal covers shall be permitted to enclose wiring methods and cables, not already covered in 300.22 (C)(1), in accordance with 392.10 (A) and (B).

(3) Equipment. Electrical equipment with a metal enclosure, or electrical equipment with a nonmetallic enclosure listed for use within an air-handling space and having adequate fire-resistant and low-smoke-producing characteristics, and associated wiring material suitable for the ambient temperature shall be permitted to be installed in such other space unless prohibited elsewhere in this Code.

Informational Note: One method of defining adequate fire-resistant and low-smoke producing characteristics for electrical equipment with a nonmetallic enclosure is in ANSI/UL 2043-2008, Fire Test for Heat and Visible Smoke Release for Discrete Products and Their Accessories Installed in Air-Handling Spaces.

Exception: Integral fan systems shall be permitted where specifically identified for use within an air-handling space.

(D) Information Technology Equipment. Electrical wiring in air-handling areas beneath raised floors for information technology equipment shall be permitted in accordance with Article 645.

310.15 Ampacities for Conductors Rated 0–2000 Volts.

(B) Tables...

(3) Adjustment Factors.

(a) **More Than Three Current-Carrying Conductors.** Where the number of current-carrying conductors in a raceway or cable exceeds three, or where single conductors or multiconductor cables are installed without maintaining spacing for a continuous length longer than 600mm (24 in.) and are not installed in raceways, the allowable ampacity of each conductor shall be reduced as shown in Table 310.15 (B)(3)(a). Each current-carrying conductor of a paralleled set of conductors shall be counted as a current-carrying conductor.

Where conductors of different systems, as provided in 300.3, are installed in a common raceway or cable, the adjustment factors shown in Table 310.15 (B)(3)(a) shall apply only to the number of power and lighting conductors (Articles 210, 215, 220, and 230).

Informational Note No. 1: See Annex B, for adjustment factors for more than three current-carrying conductors in a raceway or cable with load diversity.

Informational Note No. 2: See 366.23 (A) for adjustment factors for conductors in sheet metal auxiliary gutters and 376.22 (B) for adjustment

factors for conductors in metal wireways.

(4) Adjustment factors shall not apply to Type AC cable or to Type MC cable under the following conditions:

- a. The cables do not have an overall outer jacket.
 - b. Each cable has not more than three current-carrying conductors.
 - c. The conductors are 12 AWG copper.
 - d. Not more than 20 current-carrying conductors are installed without maintaining spacing, are stacked, or are supported on “bridle rings.”
- (5) An adjustment factor of 60 percent shall be applied to Type AC cable or Type MC cable under the following conditions:

- a. The cables do not have an overall outer jacket.
- b. The number of current carrying conductors exceeds 20.
- c. The cables are stacked or bundled longer than 600mm (24 in.) without spacing being maintained.

314.23 Supports. Enclosures within the scope of this article shall be supported in accordance with one or more of the provisions in 314.23 (A) through (H).

(C) Mounting in Finished Surfaces. An enclosure mounted in a finished surface shall be rigidly secured thereto by clamps, anchors, or fittings identified for the application.

(D) Suspended Ceilings. An enclosure mounted to structural or supporting elements of a suspended ceiling shall be not more than 1650cm³ (100 in.³) in size and shall be securely fastened in place in accordance with either (D)(1) or (D)(2).

(1) Framing Members. An enclosure shall be fastened to the framing members by mechanical means such as bolts, screws, or rivets, or by the use of clips or other securing means identified for use with the type of ceiling framing member(s) and enclosure(s) employed. The framing members shall be supported in an approved manner and securely fastened to each other and to the building structure.

2) Support Wires. The installation shall comply with the provisions of 300.11 (A). The enclosure shall be secured, using identified methods, to ceiling support wire(s), including any additional support wire(s) installed for ceiling support. Support wire(s) used for enclosure support shall be fastened at each end so as to be taut within the ceiling cavity.

(E) Raceway Supported Enclosure, without Devices,

Luminaires, or Lampholders. An enclosure that does not contain a device(s), other than splicing devices, or supports a luminaire(s), a lampholder, or other equipment and is supported by entering raceways shall not exceed 1650cm³ (100 in.³) in size. It shall have threaded entries or identified hubs. It shall be supported by two or more conduits threaded wrenchtight into the enclosure or hubs. Each conduit shall be secured within 900mm (3 ft.) of the enclosure, or within 450mm (18 in.) of the enclosure if all conduit entries are on the same side.

Exception: The following wiring methods shall be permitted to support a conduit body of any size, including a conduit body constructed with only one conduit entry, provided that the trade size of the conduit body is not larger than the largest trade size of the conduit or tubing:

- (1) Intermediate metal conduit, Type IMC
- (2) Rigid metal conduit, Type RMC
- (3) Rigid polyvinyl chloride conduit, Type PVC
- (4) Reinforced thermosetting resin conduit, Type RTRC
- (5) Electrical metallic tubing, Type EMT

(F) Raceway-Supported Enclosures, with Devices, Luminaires, or Lampholders. An enclosure that contains a device(s), other than splicing devices, or supports a luminaire(s), a lampholder, or other equipment and is supported by entering raceways shall not exceed 1650cm³ (100 in.³) in size. It shall have threaded entries or identified hubs. It shall be supported by two or more conduits threaded wrenchtight into the enclosure or hubs.

StrongHold™ Codes and Standards

Each conduit shall be secured within 450mm (18 in.) of the enclosure.

Exception No. 1: Rigid metal or intermediate metal conduit shall be permitted to support a conduit body of any size, including a conduit body constructed with only one conduit entry, provided the trade size of the conduit body is not larger than the largest trade size of the conduit.

Exception No. 2: An unbroken length(s) of rigid or intermediate

metal conduit shall be permitted to support a box used for luminaire or lampholder support, or to support a wiring enclosure that is an integral part of a luminaire and used in lieu of a box in accordance with 300.15 (B), where all of the following conditions are met:

(a) The conduit is securely fastened at a point so that the length of conduit beyond the last point of conduit support does not exceed 900mm (3 ft.). (b) The unbroken conduit length before the last point of conduit support is 300mm (12 in.) or greater, and that portion of the conduit is securely fastened at some point not less than 300mm (12 in.) from its last point of support.

(c) Where accessible to unqualified persons, the luminaire or lampholder, measured to its lowest point, is at least 2.5m (8 ft.) above grade or standing area and at least 900mm (3 ft.) measured horizontally to the 2.5m (8 ft.) elevation from windows, doors, porches, fire escapes, or similar locations. (d) A luminaire supported by a single conduit does not exceed 300mm (12 in.) in any direction from the point of conduit entry.

(e) The weight supported by any single conduit does not exceed 9 kg (20 lbs.).

(f) At the luminaire or lampholder end, the conduit(s) is threaded wrenchtight into the box, conduit body, integral wiring enclosure, or identified hubs. Where a box or conduit body is used for support, the luminaire shall be secured directly to the box or conduit body, or through a threaded conduit nipple not over 75mm (3 in.) long.

314.27 Outlet Boxes.

(A) Boxes at Luminaire or Lampholder Outlets. Outlet boxes or fittings designed for the support of luminaires and lampholders, and installed as required by 314.23, shall be permitted to support a luminaire or lampholder.

(2) Ceiling Outlets. At every outlet used exclusively for lighting, the box shall be designed or installed so that a luminaire or lampholder may be attached. Boxes shall be required to support a luminaire weighing a minimum of 23 kg (50 lbs.). A luminaire that weighs more than 23 kg (50 lbs.) shall be supported independently of the outlet box, unless the outlet box is listed and marked on the interior of the box to indicate the maximum weight the box shall be permitted to support.

320.2 Definition.

Armored Cable, Type AC. A fabricated assembly of insulated conductors in a flexible interlocked metallic armor. See 320.100.

320.17 Through or Parallel to Framing Members. Type AC cable shall be protected in accordance with 300.4 (A), (C), and (D) where installed through or parallel to framing members.

320.30 Securing and Supporting.

(A) General. Type AC cable shall be supported and secured by staples, cable ties, straps, hangers, or similar fittings, designed and installed so as not to damage the cable.

(B) Securing. Unless otherwise permitted, Type AC cable shall be secured within 300mm (12 in.) of every outlet box, junction box, cabinet, or fitting and at intervals not exceeding 1.4m (4 1/2 ft.) where installed on or across framing members.

(C) Supporting. Unless otherwise permitted, Type AC cable shall be supported at intervals not exceeding 1.4m (4 1/2 ft.).

Horizontal runs of Type AC cable installed in wooden or metal framing members or similar supporting means shall be considered supported where such support does not exceed 1.4m (4 1/2 ft.) intervals.

330.2 Definition.

Metal Clad Cable, Type MC. A factory assembly of one or more insulated circuit conductors with or without optical fiber members enclosed in an

armor of interlocking metal tape, or a smooth or corrugated metallic sheath.

330.17 Through or Parallel to Framing Members.

Type MC cable shall be protected in accordance with 300.4 (A), (C), and (D) where installed through or parallel to framing members.

330.30 Securing and Supporting.

(A) General. Type MC cable shall be supported and secured by staples, cable ties, straps, hangers, or similar fittings or other approved means designed and installed so as not to damage the cable.

(B) Securing. Unless otherwise provided, cables shall be secured at intervals not exceeding 1.8m (6 ft.). Cables containing four or fewer conductors sized no larger than 10 AWG shall be secured within 300mm (12 in.) of every box, cabinet, fitting, or other cable termination. In vertical installations, listed cables with ungrounded conductors 250 kcmil and larger shall be permitted to be secured at intervals not exceeding 3m (10 ft.).

(C) Supporting. Unless otherwise provided, cables shall be supported at intervals not exceeding 1.8m (6 ft.). Horizontal runs of Type MC cable installed in wooden or metal framing members or similar supporting means shall be considered supported and secured where such support does not exceed 1.8m (6 ft.) intervals.

334.2 Definitions.

Nonmetallic-Sheathed Cable. A factory assembly of two or more insulated conductors enclosed within an overall nonmetallic jacket.

334.17 Through or Parallel to Framing Members.

Types NM, NMC, or NMS cable shall be protected in accordance with 300.4 where installed through or parallel to framing members. Grommets used as required in 300.4 (B)(1) shall remain in place and be listed for the purpose of cable protection.

334.30 Securing and Supporting.

Nonmetallic-sheathed cable shall be supported and secured by staples, cable ties, straps, hangers, or similar fittings designed and installed so as not to damage the cable, at intervals not exceeding 1.4m (4 1/2 ft.) and within 300mm (12 in.) of every outlet box, junction box, cabinet, or fitting. Flat cables shall not be stapled on edge. Sections of cable protected from physical damage by raceway shall not be required to be secured within the raceway.

(A) Horizontal Runs Through Holes and Notches.

In other than vertical runs, cables installed in accordance with 300.4 shall be considered to be supported and secured where such support does not exceed 1.4m (4 1/2 ft.) intervals and the nonmetallic-sheathed cable is securely fastened in place by an approved means within 300mm (12 in.) of each box, cabinet, conduit body, or other nonmetallic-sheathed cable termination.

Informational Note: See 314.17 (C) for support where nonmetallic boxes are used.

342.30 Securing and Supporting.

IMC shall be installed as a complete system in accordance with 300.18 and shall be securely fastened in place and supported in accordance with 342.30 (A) and (B).

(A) Securely Fastened. IMC shall be secured in accordance with one of the following:

(1) IMC shall be securely fastened within 900mm (3 ft.) of each outlet box, junction box, device box, cabinet, conduit body, or other conduit termination.

(2) Where structural members do not readily permit fastening within 900mm (3 ft.), fastening shall be permitted to be increased to a distance of 1.5m (5 ft.).

(3) Where approved, conduit shall not be required to be securely fastened within 900mm (3 ft.) of the service head for above-the-roof termination of a mast.

(B) Supports. IMC shall be supported in accordance with one of the following:

StrongHold™ Codes and Standards

(1) Conduit shall be supported at intervals not exceeding 3m (10 ft.).

(2) The distance between supports for straight runs of conduit shall be permitted in accordance with Table 344.30 (B)(2), provided the conduit is made up with threaded couplings and such supports prevent transmission of stresses to termination where conduit is deflected between supports.

344.30 Securing and Supporting. RMC shall be installed as a complete system in accordance with 300.18 and shall be securely fastened in place and supported in accordance with 344.30 (A) and (B).

(A) Securely Fastened. RMC shall be secured in accordance with one of the following:

(1) RMC shall be securely fastened within 900mm (3 ft.) of each outlet box, junction box, device box, cabinet, conduit body, or other conduit termination.

(2) Fastening shall be permitted to be increased to a distance of 1.5m (5 ft.) where structural members do not readily permit fastening within 900mm (3 ft.).

(3) Where approved, conduit shall not be required to be securely fastened within 900mm (3 ft.) of the service head for above-the-roof termination of a mast.

(B) Supports. RMC shall be supported in accordance with one of the following:

(1) Conduit shall be supported at intervals not exceeding 3m (10 ft.).

(2) The distance between supports for straight runs of conduit shall be permitted in accordance with Table 344.30 (B)(2), provided the conduit is made up with threaded couplings and such supports prevent transmission of stresses to termination where conduit is deflected between supports.

348.30 Securing and Supporting. FMC shall be securely fastened in place and supported in accordance with 348.30 (A) and (B).

(A) Securely Fastened. FMC shall be securely fastened in place by an approved means within 300mm (12 in.) of each box, cabinet, conduit body, or other conduit termination and shall be supported and secured at intervals not to exceed 1.4m (4 1/2 ft.).

(B) Supports. Horizontal runs of FMC supported by openings through framing members at intervals not greater than 1.4m (4 1/2 ft.) and securely fastened within 300mm (12 in.) of termination points shall be permitted.

358.30 Securing and Supporting. EMT shall be installed as a complete system in accordance with 300.18 and shall be securely fastened in place and supported in accordance with 358.30 (A) and (B).

(A) Securely Fastened. EMT shall be securely fastened in place at least every 3m (10 ft.). In addition, each EMT run between termination points shall be securely fastened within 900mm (3 ft.) of each outlet box, junction box, device box, cabinet, conduit body, or other tubing termination.

Exception No. 1: Fastening of unbroken lengths shall be permitted to be increased to a distance of 1.5m (5 ft.) where structural members do not readily permit fastening within 900mm (3 ft.).

Exception No. 2: For concealed work in finished buildings or prefinished wall panels where such securing is impracticable, unbroken lengths (without coupling) of EMT shall be permitted to be fished.

(B) Supports. Horizontal runs of EMT supported by openings through framing members at intervals not greater than 3m (10 ft.) and securely fastened within 900mm (3 ft.) of termination points shall be permitted.

362.2 Definition.

Electrical Nonmetallic Tubing (ENT). A nonmetallic, pliable, corrugated raceway of circular cross section with integral or associated couplings, connectors, and fittings for the installation of electrical conductors. ENT is composed of a material that is resistant to moisture and chemical atmospheres and is flame retardant. A pliable raceway is a raceway that

can be bent by hand with a reasonable force but without other assistance.

362.30 Securing and Supporting. ENT shall be installed as a complete system in accordance with 300.18 and shall be securely fastened in place and supported in accordance with 362.30 (A) and (B).

(A) Securely Fastened. ENT shall be securely fastened at intervals not exceeding 900mm (3 ft.). In addition, ENT shall be securely fastened in place within 900mm (3 ft.) of each outlet box, device box, junction box, cabinet, or fitting where it terminates.

Exception No. 1: Lengths not exceeding a distance of 1.8m (6 ft.) from a luminaire terminal connection for tap connections to lighting luminaires shall be permitted without being secured.

Exception No. 2: Lengths not exceeding 1.8m (6 ft.) from the last point where the raceway is securely fastened for connections within an accessible ceiling to luminaire(s) or other equipment.

Exception No. 3: For concealed work in finished buildings or prefinished wall panels where such securing is impracticable, unbroken lengths (without coupling) of ENT shall be permitted to be fished.

410.36 Means of Support.

(A) Outlet Boxes. Outlet boxes or fittings installed as required by 314.23 and complying with the provisions of 314.27 (A)(1) and 314.27 (A)(2) shall be permitted to support luminaires.

(B) Suspended Ceilings. Framing members of suspended ceiling systems used to support luminaires shall be securely fastened to each other and shall be securely attached to the building structure at appropriate intervals. Luminaires shall be securely fastened to the ceiling framing member by mechanical means such as bolts, screws, or rivets. Listed clips identified for use with the type of ceiling framing member(s) and luminaire(s) shall also be permitted.

410.154 Fastening. Lighting track shall be securely mounted so that each fastening is suitable for supporting the maximum weight of luminaires that can be installed. Unless identified for supports at greater intervals, a single section 1.2m (4 ft.) or shorter in length shall have two supports, and, where installed in a continuous row, each individual section of not more than 1.2m (4 ft.) in length shall have one additional support.

590.4 General.

(J) Support. Cable assemblies and flexible cords and cables shall be supported in place at intervals that ensure that they will be protected from physical damage. Support shall be in the form of staples, cable ties, straps, or similar type fittings installed so as not to cause damage. Cable assemblies and flexible cords and cables installed as branch circuits or feeders shall not be installed on the floor or on the ground. Extension cords shall not be required to comply with 590.4(J). Vegetation shall not be used for support of overhead spans of branch circuits or feeders.

Exception: For holiday lighting in accordance with 590.3 (B), where the conductors or cables are arranged with strain relief devices, tension take-up devices, or other approved means to avoid damage from the movement of the live vegetation, trees shall be permitted to be used for support of overhead spans of branch-circuit conductors or cables.

604.7 Installation. Manufactured wiring systems shall be secured and supported in accordance with the applicable cable or conduit article for the cable or conduit type employed.

725.24 Mechanical Execution of Work. Class 1, Class 2, and Class 3 circuits shall be installed in a neat and workmanlike manner. Cables and conductors installed exposed on the surface of ceilings and sidewalls shall be supported by the building structure in such a manner that the cable will not be damaged by normal building use. Such cables shall be supported by straps, staples, hangers, cable ties, or similar fittings designed and installed so as not to damage the cable. The installation shall also comply with 300.4 (D).

760.24 Mechanical Execution of Work.

(A) General. Fire alarm circuits shall be installed in a neat workmanlike

StrongHold™ Codes and Standards

manner. Cables and conductors installed exposed on the surface of ceilings and sidewalls shall be supported by the building structure in such a manner that the cable will not be damaged by normal building use. Such cables shall be supported by straps, staples, cable ties, hangers, or similar fittings designed and installed so as not to damage the cable. The installation shall also comply with 300.4 (D).

800.24 Mechanical Execution of Work.

Communications circuits and equipment shall be installed in a neat and workmanlike manner. Cables installed exposed on the surface of ceilings and sidewalls shall be supported by the building structure in such a manner that the cable will not be damaged by normal building use. Such cables shall be secured by hardware, including straps, staples, cable ties, hangers, or similar fittings designed and installed so as not to damage the cable. The installation shall also conform to 300.4 (D) and 300.11. Nonmetallic cable ties and other nonmetallic cable accessories used to secure and support cables in other spaces used for environmental air (plenums) shall be listed as having low smoke and heat release properties.

Informational Note No. 1: Accepted industry practices are described in ANSI/NECA/BICSI 568-2006, Standard for Installing Commercial Building Telecommunications Cabling; ANSI/TIA/EIA-568-B.1-2004 — Part 1, General Requirements

Commercial Building Telecommunications Cabling Standard; ANSI/TIA-569-B-2004, Commercial Building Standard for Telecommunications Pathways and Spaces; ANSI/TIA-570-B, Residential Telecommunications Infrastructure, and other ANSI-approved installation standards.

Informational Note No. 2: See 4.3.11.2.6.5 and 4.3.11.5.5.6 of NFPA 90A-2012, Standard for the Installation of Air-Conditioning and Ventilating Systems, for discrete combustible components installed in accordance with 300.22 (C).

Telecommunications Pathways and Spaces; ANSI/TIA-569-C; Revision May, 2012

6.7.6 Low-Voltage Mounting Bracket

A low-voltage mounting bracket is similar to a plaster ring and may be used in place of an outlet box where permitted by code.

9.3.2 Telecommunications Pathway Separation From Lighting

Balanced twisted-pair cabling should be separated from fluorescent lamps and associated fixtures by a minimum of 125mm (5 in.).

9.4.2.1 Planning

The design shall provide a suitable means and method for supporting cables. Cable shall not be laid directly on the ceiling tile or rails.

9.4.2.2 Clearance

A minimum of 75mm (3 in.) clear vertical space shall be available above the ceiling tiles for the cabling and pathway.

9.5.4.3 Cable Management

Providing physical management for cabling placed within the access floor system lessens the chance of damage or reduced performance over the cable's life cycle. A method of physical management for major runs of cabling shall be provided. Management systems such as raceways, cable tray, and non-continuous cable supports may be used.

9.7 Non-Continuous Support

Non-continuous supports shall be located at intervals not to exceed 1.5m (5 ft.). Non-continuous supports shall be selected to accommodate the immediate and anticipated quantity, weight, and performance requirements of cables.

Steel, masonry, independent rods, independent support wires or other structural parts of the building shall be used for cable support attachment points up to the total weight for which the fastener is approved. Rods or wires that are currently employed for other functions (e.g., suspended ceiling grid support) shall not be utilized as attachment points for non-continuous supports.

NOTE: A weight of 1 kg (2.2 lbs.) (or 0.7 kg/m [0.5 lb./ft.] with spacing of

support wire/rod at 1.5m [5 ft.]) is equivalent to a bundle of sixteen 4-pair 24 AWG UTP cables, including fasteners.

9.8.3.1 Conduit Termination

Conduits shall be reamed to eliminate sharp edges. Metallic conduit shall be terminated with an insulated bushing.

BICSI TDMM, 12th Edition; 2009 Revision

Page 5-1: Introduction

Horizontal pathways include:

- Continuous pathways (e.g., conduit cable tray and cable matting) used for containment of telecommunications cabling
- Non-continuous pathways (e.g., the space between open-top cable supports [J-hooks]) through which cable is placed between physical support or containment components

Pages 5-39-5-41: Pathway and Cable Support

Every ceiling distribution system must provide proper support for cables from the telecommunications space to the work areas served. Ceiling panels, support channels (T-bars), and suspended ceiling support wires are not proper cabling supports.

Ceiling conduits, raceways, cable trays, and cabling must be suspended from or attached to the structural ceiling or walls with hardware or other installation aids specifically designed to support their weight.

The pathways must:

- Have adequate support to withstand cable pulling
- Be installed with at least 75mm (3 in.) of clear vertical space above the ceiling tiles and support channels (T-bars) to ensure accessibility

Horizontal pathways or cable should not rest directly on or be supported by:

- Ceiling panels
- Support channels (T-bars)
- Ceiling support wires
- Other components of the suspended ceiling

It is important to provide sufficient space between the suspended ceiling structure and the telecommunications pathways/cables to install, maneuver, and store ceiling tiles during service. When sufficient space is available above the pathway, up to 150mm (6 in.) should be provided between the suspended ceiling and the cabling pathways.

Where building codes permit telecommunications cable to be placed in suspended ceiling spaces without conduit, ceiling zone distribution pathways may consist of:

- Cable trays
- Open-top supports (e.g., J-hooks)

NOTE: J-hooks should be located 1.5m (5 ft.) apart at the maximum to adequately support and distribute the cable's weight. The manufacturer's specifications for cable loading should be followed.

Cable support devices that have narrow surface areas to support the cable laying horizontally inside or on top may have a detrimental effect on the transmissions performance of higher performance cabling systems.

If possible, a wider surface area should be chosen to support the cable as a precaution against potential problems. Another precaution would be to reduce the distance between the support devices.

Suspended cables must be installed with at least 75mm (3 in.) of clear vertical space above the ceiling tiles and support channels (T-bars).

For large quantities of cables (50 or more) that converge at the ER, TR, and other areas, provide cable trays or other special supports that are specifically designed to support the required cable weight and volume.

Page 5-57: Telecommunications Outlets/Connectors

Telecommunications outlet/connector boxes must be used in fire-rated wall installations and must be firestopped appropriately. Low-voltage

StrongHold™ Codes and Standards

mounting brackets (e.g., also known as mud ring, plaster ring, square-drawn cover, and box eliminator) may be used where the wall is not fire rated, and are typically used for work associated with MACs.

Telecommunications outlet/connector boxes installed in dry wall, plaster, or concrete block wall are available in an array of shapes and sizes. The size of each telecommunications outlet/connector box must be of a size that is adequate to accommodate the type and density of cabling to be installed.

Telecommunications outlet/connector boxes should not be placed back to back to serve adjacent rooms. This can compromise the effectiveness of the wall as a sound barrier and as a firestop.

J-Pro™ Cable Support System – Frequently Asked Questions

Question:

What references define how and where J-hooks are used?

Answer:

J-hooks are a horizontal pathway promoted in the BICSI® TDM manual as a means to route cable bundles (see catalog pages O.14 – O.15). Furthermore, the TIA-569-C standard promotes non-continuous supports as a means to route cable bundles as well (see catalog page O.13). According to Underwriters Laboratories Inc. (UL), the portion of the NEC® that defines the requirements of this cabling pathway is found in Section 300.22 of the NEC (see catalog pages O.2 – O.4).

Question:

What is the difference between plenum space and air handling space?

Answer:

The industry-wide confusion regarding the definition of a plenum space versus an air handling space is very common as the area above a drop ceiling is mistakenly referred to as a plenum.

Simply stated, the NEC defines a plenum area as, “a compartment or chamber to which one or more air ducts are connected and that forms part of the air distribution system.” They also reference, “the space over a hung ceiling used for environmental air-handling purposes,” and, “areas beneath raised floors for information technology equipment,” as air handling space (NEC pg. 70-144 and 70-145; see catalog pages O.2 – O.4). Often, the NEC definition of these terms differs from their common use in the industry – however, UL is compatible with the NEC terms and definitions. Therefore, the space above a hung (or drop/suspended) ceiling utilized as an air return to the HVAC unit is considered an air handling space. Additionally, the area below a raised floor used to supply conditioned air is also considered an air handling space.

Question:

Is the J-Pro™ Cable Support System approved by UL for use in air handling spaces in the United States?

Answer:

Yes, during the development of the J-Pro™ Cable Support System, Panduit coordinated testing and evaluation with UL for approval of the following statement on all the J-Pro™ Cable Support System products to reduce confusion in the market: “Suitable for use in air handling spaces in accordance with Section 300.22 (C) and (D) of the NEC....” This statement is engraved and is visible on the side or bottom of each part. According to this phrase, the J-Pro™ Cable Support System can be utilized in the area above the suspended ceiling (300.22 [C]) or below a raised floor (300.22 [D]), but it cannot be utilized within ductwork (300.22 [A] and [B]) (see catalog pages O.2 – O.4). Approval to use J-Pro™ Cable Support System above the suspended ceiling and below the raised floor was a result of completing/passing testing of the J-Pro™ Cable Support System per the UL standard UL2043, Fire Test for Visible Heat and Smoke Release for Discrete Products and their Accessories Installed in Air-Handling Spaces. This test requires product to meet certain criteria for heat release and smoke density and the values measured correlate back to the maximum flame spread and smoke index of the mechanical code. The basic standard used to investigate products in this category is ANSI/UL 1565, “Positioning Devices”. The J-Pro™ Cable Support System product line is UL listed within UL file number E136577.

Order number of pieces required, in multiples of standard package quantity.

Question:

Is the J-Pro™ Cable Support System approved by Underwriters’ Laboratories of Canada (ULC) for use in air handling spaces?

Answer:

Yes, for applications within Canada, the J-Pro™ Cable Support System was tested and evaluated by ULC for approval of the following statement, “In accordance with CAN/ULC S102.2 in single units or pairs. 4-foot minimum spacing, FSR = 0, SDC = 35.” This statement is engraved and visible on the side or bottom of each part. According to this phrase, the J-Pro™ Cable Support System is approved for the same air handling spaces as defined by the NEC Article 300.22 (C) and (D) (above the suspended ceiling or below a raised floor) and meets the S102.2 (Standard Method of Test for Surface Burning Characteristics of Floor Coverings, and Miscellaneous Material and Assemblies) requirements as stated in the National Building Code of Canada. The J-Pro™ Cable Support System product line is ULC listed within ULC file number R21673.

UL

File E136577
Volume 2, Section 2
Page 1.1

ULC

File R21673
Volume 1

Description

Product Covered:

USL, CNL – Positioning Devices – Model JP2, JP4, JP75, JP131

General Description:

USL, CNL – Indicates that the products have been evaluated in accordance with the requirements in UL 1565 and CAN/CSA C22.2 No. 18.5-02 Standards for Positioning Devices.

These devices are a J-Pro™ J-hook, and are used in applications where zone conduit, cable trays, or ladder racks are not available or applicable.

The J-Pro™ J-hook contains a family of parts. This system has several other brackets and/or components, manufactured from a high-carbon plated steel, riveted to the JP2, JP4, JP75, and JP131 for a variety of applications.

Family of Part Numbers	J-Pro™ Cable Support System Description
JP2	J-Pro™ J-hook

Ratings: These devices are rated 60°C, for indoor use, suitable for use in air handling spaces in accordance with Sec. 300.22 (C) and (D) of the National Electrical Code in single units or pairs, and 30 lb. maximum load rating.

Family of Part Numbers	J-Pro™ Cable Support System Description
JP4	J-Pro™ J-hook

Ratings: These devices are rated 60°C, for indoor use, suitable for use in air handling spaces in accordance with Sec. 300.22 (C) and (D) of the National Electrical Code, and 100 lb. maximum load rating in single unit configuration only.

Family of Part Numbers	J-Pro™ Cable Support System Description
JP75	J-Pro™ J-hook

Ratings: These devices are rated 60°C, for indoor use, suitable for use in air handling spaces in accordance with Sec. 300.22 (C) and (D) of the National Electrical Code in single units or pairs, and 15 lb. maximum load rating.

Family of Part Numbers	J-Pro™ Cable Support System Description
JP131	J-Pro™ J-hook

Ratings: These devices are rated 60°C, for indoor use, suitable for use in air handling spaces in accordance with Sec. 300.22 (C) and (D) of the National Electrical Code in single units or pairs, and 20 lb. maximum load rating.

1 Scope

1:1 This standard applies to those metallic and nonmetallic devices used for positioning – which may include bundling and securing – or to a limited extent supporting cable, wire, conduit, or tubing of a wiring system in electrical installations, to reduce the risk of fire, electric shock, or injury to persons. This standard applies to, but is not limited to, cable ties, cable tie mounting blocks, cable clamps, cable and conduit clips, and non-raceway ducts.

P20M24SM	19	PM912S	22	S8-40-M	3	S48-175-L	5
P32M24	19	PMCS100	19	S8-40-MO	3	S48-175-LO	5
P32M24SM	19	PMEB1	24	S8-50-C	4	S48-175-L8	5
P32M58	19	PRBS16	25	S8-50-C0	4	SC8-50-S10-C	5
P304B2	24	PRBS24	25	S8-50-M	4	SC8-50-S10-C0	5
P449	19	PRLC	32	S8-50-MO	4	SC15-120-S25-L	5
P512	33	PSC2B	21	S10-50-C	4	SC15-120-S25-LO	5
P512A	33	PSC2C	21	S10-50-C0	4	SMP12A-3X	6
P512HDK	33	PSC4B	21	S12-40-C	4	SMP12A-3X0	6
P515A	33	PSC4C	21	S12-40-C0	4	SMP12A-C	6
P812M24	19	PSC4D	21	S12-40-M	4	SMP12A-C0	6
P812M24SM	19	PSC4E	21	S12-40-MO	4	SMP12A-M	6
P812M58	19	PSCB-3Y	17	S12-50-C	4	SMP12A-MO	6
P812M58SM	19	PSCB-3YELY*	17	S12-50-C0	4	SMP16A-3X	6
P812M912	19	PSCB-5Y	17	S12-50-C2	4	SMP16A-3X0	6
P812M912SM	19	PSCB-6Y	17	S12-50-M	4	SMP16A-C	6
P812MB18	21	PSCB-12Y	17	S12-50-MO	4	SMP16A-C0	6
P812MB18A	21	PSCB-13Y	17	S14-120-L	5	SMP16A-M	6
P812MB18S	21	PSCB-16Y	17	S14-120-LO	5	SMP16A-MO	6
PBC	22	PSCH6B	21	S14-120-TL	5	SMP18A-3X	6
PBC*	22	PSCH8B	21	S14-120-TLO	5	SMP18A-3X0	6
PBC20M	23	PSCH12B	21	S15-40-C	4	SMP18A-C	6
PBC200	22	PSCH16B	21	S15-40-C0	4	SMP18A-C0	6
PBC200CD1B	23	PSCH24B	21	S15-50-C	4	SMP18A-M	6
PBC400	22	PSCH32B	21	S15-50-C0	4	SMP18A-MO	6
PBC812M	23	PSCH40B	21	S15-50-C2	4	SR8-50-C	5
PBC812MSM	23	PSCH72B	21	S15-50-M	4	SR8-50-C0	5
PCATHBA	28	PSK85I	21	S15-50-MO	4	SS2S6-MO	6
PCDOB	19	PSK165I	21	S17-50-C	4	SSM2S6-3X	6
PCD1B	19	PSK405I	21	S17-50-C0	4	SSM2S6-3X0	6
PCD2B	19	PSMS8	26	S17-50-M	4	SSM2S6-C	6
PCJ6	26	PTSGB16	25	S17-50-MO	4	SSM2S6-C0	6
PCMB-1	17	PTSGB24	25	S18-120-L	5	SSM2S6-M	6
PCMB-2	17	PVF146T	23	S18-120-LO	5	SSM2S6-MO	6
PCMB-3	17			S18-175-L	5	SSM3S8-3X	6
PCMB-4	17	S		S18-175-LO	5	SSM3S8-C	6
PCMB-5	17	S4-18-C	3	S21-50-C	4	SSM3S8-C0	6
PCMB-6	17	S4-18-C0	3	S21-50-C0	4	SSM3S8-M	6
PCMB-7	17	S4-18-M	3	S21-50-M	4	SSM3S8-MO	6
PCMB-8	17	S4-18-MO	3	S21-50-MO	4	SSMLP-C	6
PCMB-9	17	S5-50-C	4	S21-120-C	5	SSMLP-M	6
PCMB-11	17	S5-50-C0	4	S21-120-C0	5	SSMTA-C	6
PCMB-12	17	S5-50-M	4	S21-120-L	5	SSMTA-M	6
PCMB-13	17	S5-50-MO	4	S21-120-LO	5	ST14-075-60BK	10
PCMB-14	17	S6-18-C	3	S21-175-C	5	ST15-075-66GRYL	10
PCMB-15	17	S6-18-C0	3	S21-175-C0	5	ST17-075-66BR	10
PCMB-16	17	S6-18-M	3	S21-175-L	5	ST17-075-66BU	10
PCMB-25	17	S6-18-MO	3	S21-175-LO	5	ST17-075-66GR	10
PCS16	24	S6-40-C	3	S24-120-L	5	ST17-075-66GY	10
PCS812D	24	S6-40-C0	3	S24-120-LO	5	ST17-075-66OR	10
PDSI2A	32	S6-40-M	3	S24-120-Q	5	ST17-075-66RD	10
PFMBS18	26	S6-40-MO	3	S24-120-Q0	5	ST17-075-66VI	10
PFXC20	26	S6-50-C	4	S24-175-L	5	ST17-075-66WH	10
PH4	24	S6-50-C0	4	S24-175-LO	5	ST17-075-66YL	10
PH6	24	S6-50-M	4	S30-120-L	5	ST35-075-66BR	10
PH23	24	S6-50-MO	4	S30-120-LO	5	ST35-075-66BU	10
PJ1A4	25	S7-50-C	4	S30-120-X	5	ST35-075-66GR	10
PJ1A6	25	S7-50-C0	4	S30-120-X0	5	ST35-075-66GY	10
PJ1A25	25	S7-50-C2	4	S31-175-L	5	ST35-075-66OR	10
PJ1A35	25	S7-50-M	4	S31-175-LO	5	ST35-075-66RD	10
PK8	20	S7-50-MO	4	S32-175-L	5	ST35-075-66VI	10
PK12	20	S8-18-C	3	S32-175-LO	5	ST35-075-66WH	10
PK16*	20	S8-18-C0	3	S36-175-L	5	ST35-075-66YL	10
PKX*	20	S8-18-M	3	S36-175-LO	5	ST43-075-66BK	10
PM24	22	S8-18-MO	3	S40-175-L	5	ST88-075-66BK	9
PM24S	22	S8-40-C	3	S40-175-LO	5	ST88-100-108BK	9
PM58	22	S8-40-C0	3	S40-175-X	5	ST88-150-66BK	9
PM58S	22			S40-175-X0	5	ST88-200-66BK	9

Panduit is a global leader in cabling and communication products, delivering end-to-end solutions in support of demanding electrical and networking requirements.

PANDUIT CATALOGS



2021 Best Seller and Featured Parts Catalog ELCB34--SA-ENG

- **Bundle**
 - Cable Ties
 - Cable Accessories
 - Stainless Steel Cable Ties and Accessories
- **Route/Protect**
 - Wiring Duct
 - Abrasion Protection
 - Cable Management
- **Terminate**
 - Terminals
 - Power Connectors
 - Grounding Connectors
- **Identification and Safety Solutions**
 - Labeling Systems
 - Labels
 - Pre-Printed and Write-On Markers
 - Permanent Identification
 - Lockout/Tagout and Safety Solutions
- **Keystone Cabling Systems**

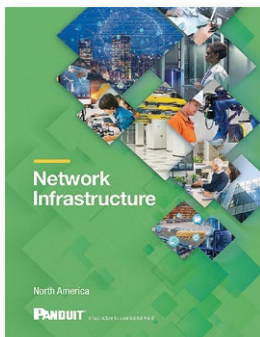

Network and Infrastructure Solutions NCCB106--SA-ENG

- Copper Systems
- Fiber Systems
- Faceplates, Outlet Frames and Surface Mount Boxes
- Keystone Cabling Systems
- Zone Cabling
- Cable Routing Systems
- Surface Raceway
- Cabinets, Racks and Cable Management Systems
- Power Management
- Grounding and Bonding
- Identification Products
- Cable Management Accessories

©2021 Panduit Corp.
ALL RIGHTS RESERVED
Printed in the U.S.A.
ELCB35--SA-ENG
Replaces ELCB32--SA-ENG
11/2021